



# BETON<sup>TM</sup> -UNO

---

Matrici per calcestruzzo a faccia vista

# BETON UNO™

## Indice

### Linea matrici STANDARD

4

MOD. <b>w01</b> <i>_Wood Collection</i> pag	5	MOD. <b>F34</b> <i>_Form Collection</i> pag	29
MOD. <b>w02</b> <i>_Wood Collection</i> pag	6	MOD. <b>F35</b> <i>_Form Collection</i> pag	30
MOD. <b>w03</b> <i>_Wood Collection</i> pag	7	MOD. <b>F61</b> <i>_Form Collection</i> pag	31
MOD. <b>w04</b> <i>_Wood Collection</i> pag	8	MOD. <b>F66</b> <i>_Form Collection</i> pag	32
MOD. <b>w05</b> <i>_Wood Collection</i> pag	9	MOD. <b>F75</b> <i>_Form Collection</i> pag	33
MOD. <b>w06</b> <i>_Wood Collection</i> pag	10	MOD. <b>F77</b> <i>_Form Collection</i> pag	34
MOD. <b>w07</b> <i>_Wood Collection</i> pag	11	MOD. <b>F78</b> <i>_Form Collection</i> pag	35
MOD. <b>w08</b> <i>_Wood Collection</i> pag	12	MOD. <b>s51</b> <i>_Stone Collection</i> pag	36
MOD. <b>w09</b> <i>_Wood Collection</i> pag	13	MOD. <b>s53</b> <i>_Stone Collection</i> pag	37
MOD. <b>w11</b> <i>_Wood Collection</i> pag	14	MOD. <b>s54</b> <i>_Stone Collection</i> pag	38
MOD. <b>w12</b> <i>_Wood Collection</i> pag	15	MOD. <b>s55</b> <i>_Stone Collection</i> pag	39
MOD. <b>w14</b> <i>_Wood Collection</i> pag	16	MOD. <b>s56</b> <i>_Stone Collection</i> pag	40
MOD. <b>w15</b> <i>_Wood Collection</i> pag	17	MOD. <b>s57</b> <i>_Stone Collection</i> pag	41
MOD. <b>w74</b> <i>_Wood Collection</i> pag	18	MOD. <b>s58</b> <i>_Stone Collection</i> pag	42
MOD. <b>F21</b> <i>_Form Collection</i> pag	20	MOD. <b>s70</b> <i>_Stone Collection</i> pag	43
MOD. <b>F22</b> <i>_Form Collection</i> pag	21	MOD. <b>s76</b> <i>_Stone Collection</i> pag	44
MOD. <b>F23</b> <i>_Form Collection</i> pag	22	MOD. <b>s80</b> <i>_Stone Collection</i> pag	45
MOD. <b>F28</b> <i>_Form Collection</i> pag	23	MOD. <b>s81</b> <i>_Stone Collection</i> pag	46
MOD. <b>F29</b> <i>_Form Collection</i> pag	24	MOD. <b>s82</b> <i>_Stone Collection</i> pag	47
MOD. <b>F30</b> <i>_Form Collection</i> pag	25	MOD. <b>s83</b> <i>_Stone Collection</i> pag	48
MOD. <b>F31</b> <i>_Form Collection</i> pag	26	MOD. <b>s84</b> <i>_Stone Collection</i> pag	49
MOD. <b>F32</b> <i>_Form Collection</i> pag	27	MOD. <b>L00</b> <i>_Stone Collection</i> pag	50
MOD. <b>F33</b> <i>_Form Collection</i> pag	28		

### Linea matrici ALTORILIEVO

51

MOD. <b>04E</b> <i>_</i> pag	52	MOD. <b>14E</b> <i>_</i> pag	56
MOD. <b>05E</b> <i>_</i> pag	52	MOD. <b>15E</b> <i>_</i> pag	57
MOD. <b>06E</b> <i>_</i> pag	53	MOD. <b>16E</b> <i>_</i> pag	57
MOD. <b>08E</b> <i>_</i> pag	53	MOD. <b>24E</b> <i>_</i> pag	58
MOD. <b>09E</b> <i>_</i> pag	54	MOD. <b>30E</b> <i>_</i> pag	58
MOD. <b>10E</b> <i>_</i> pag	54	MOD. <b>31E</b> <i>_</i> pag	59
MOD. <b>11E</b> <i>_</i> pag	55	MOD. <b>62E</b> <i>_</i> pag	59
MOD. <b>12E</b> <i>_</i> pag	55	MOD. <b>67E</b> <i>_</i> pag	60
MOD. <b>13E</b> <i>_</i> pag	56		

E' il momento della massima resa,  
della praticità e della differenza.  
Tutto con estrema facilità!

## Linea matrici STANDARD.

Linea di matrici mono-getto dai rilievi poco accentuati, disponibili in una quarantina di disegni, abbelliscono il calcestruzzo in modo semplice ed economico. Adatte per tutti i tipi di calcestruzzo, anche auto-compattanti, sono garantite per minimo un getto. Posa facile e veloce sui casseri tramite chiodi o con l'apposito adesivo, non necessitano disarmante e quindi i muri possono venire eventualmente tinteggiati immediatamente dopo il disarmo.

Le finiture della serie STANDARD conferiscono al calcestruzzo gettato superfici discrete ed eleganti o, a vostra scelta, dei disegni più pronunciati.

Le misure sono espresse in mm.

## MOD. w01

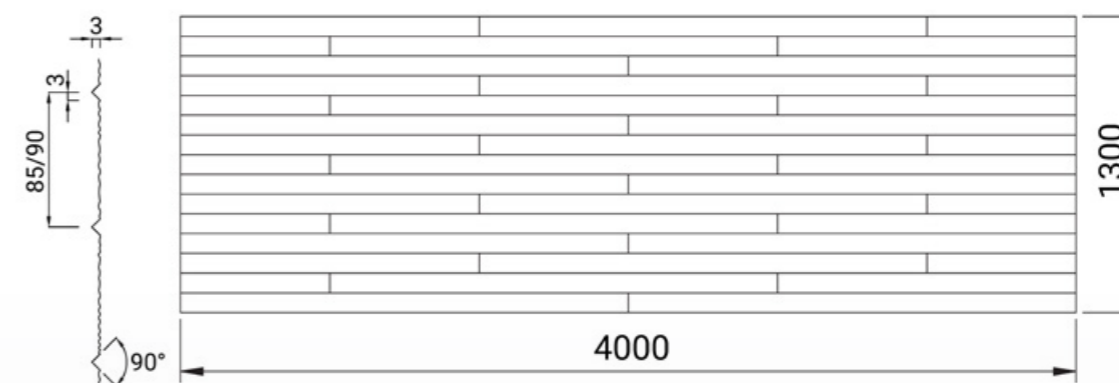

Dettaglio del getto



## Wood collection



MOD. W02

MOD. W03

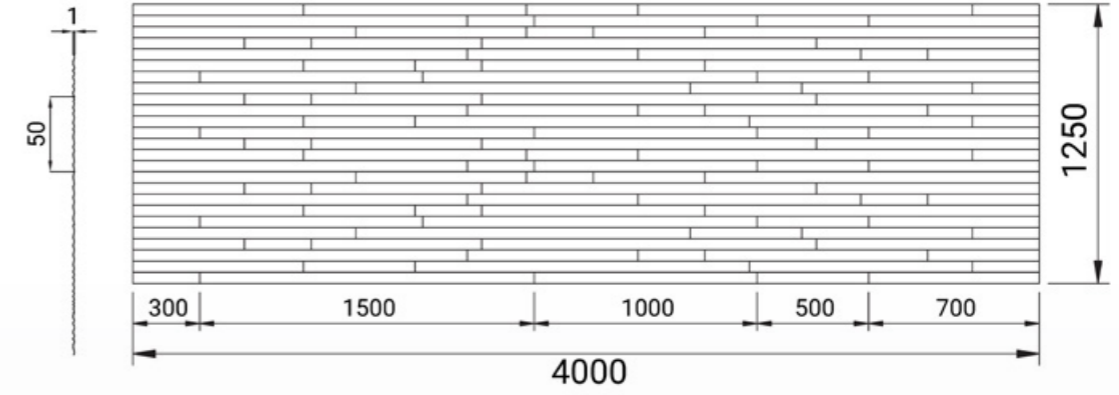
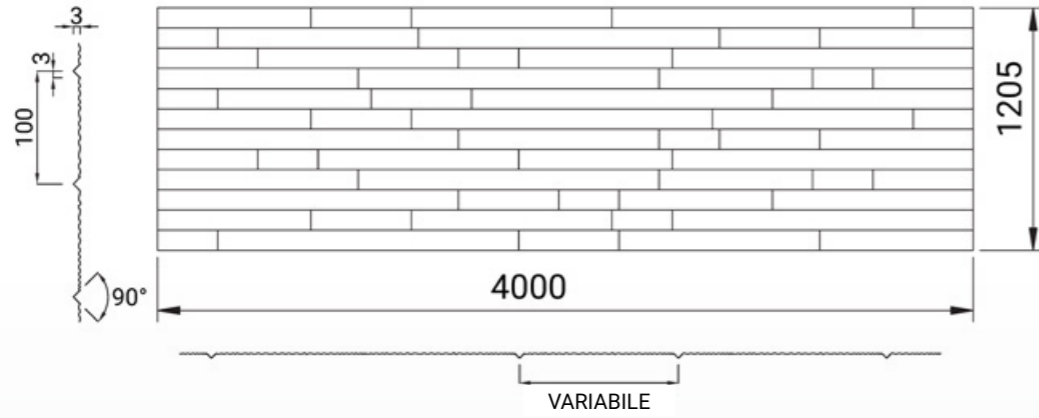

Dettaglio del getto

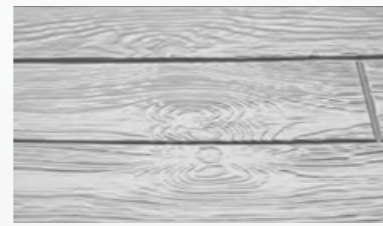

Dettaglio del getto

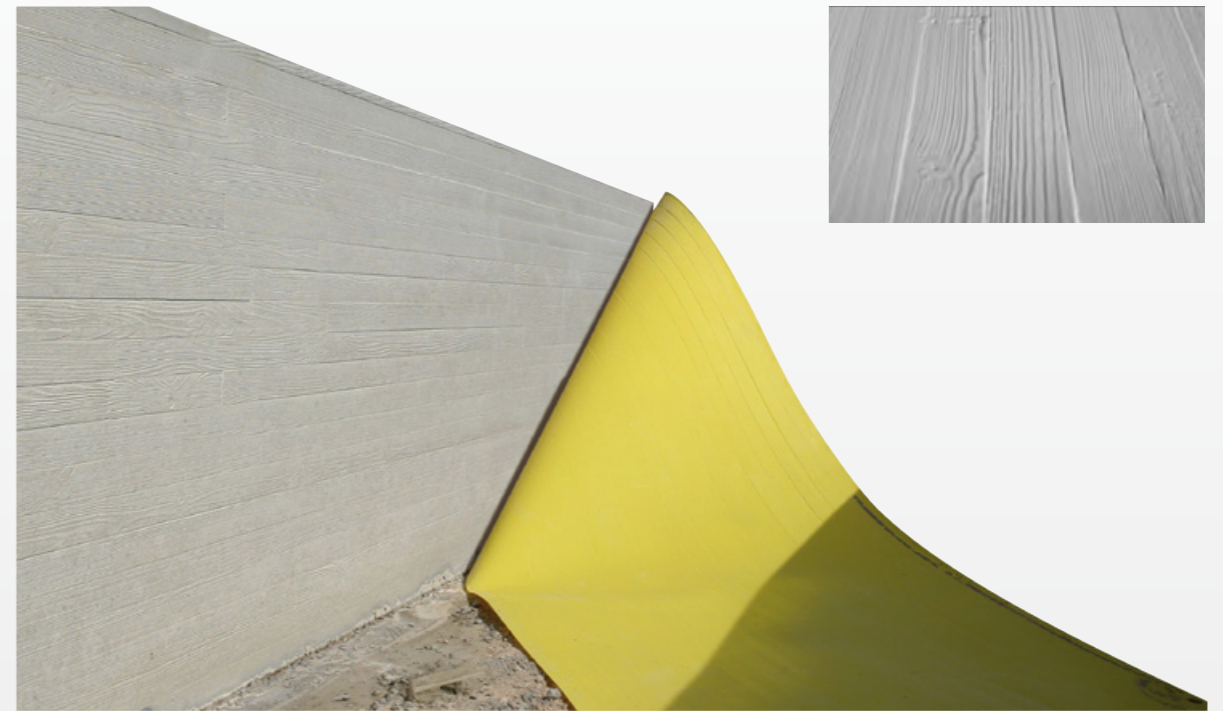
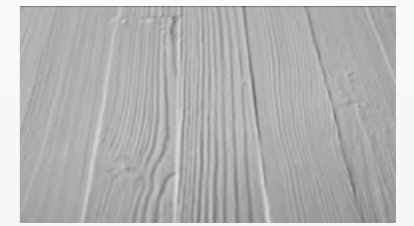

Wood collection

Wood collection



MOD. w04

MOD. w05

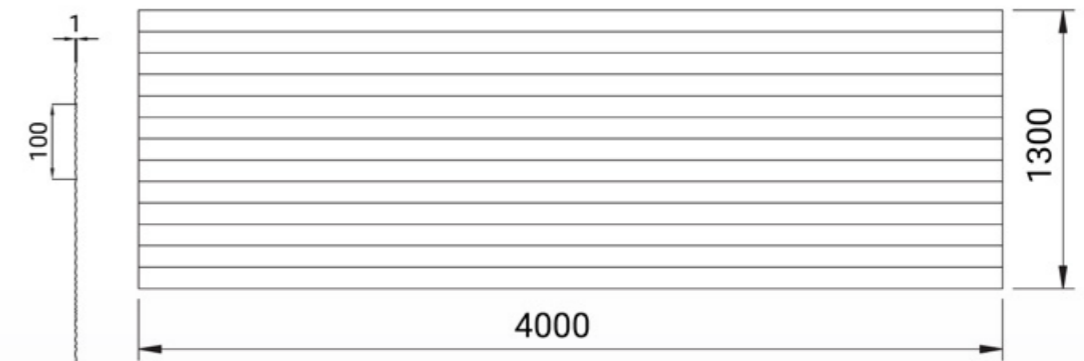
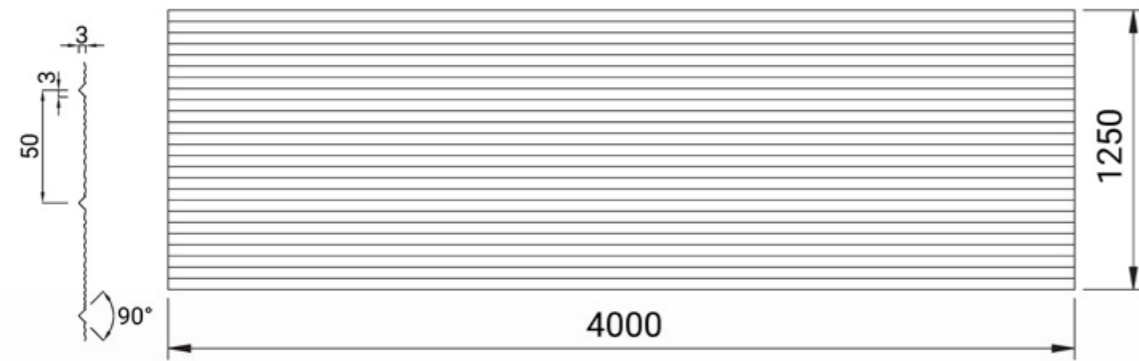

Dettaglio del getto

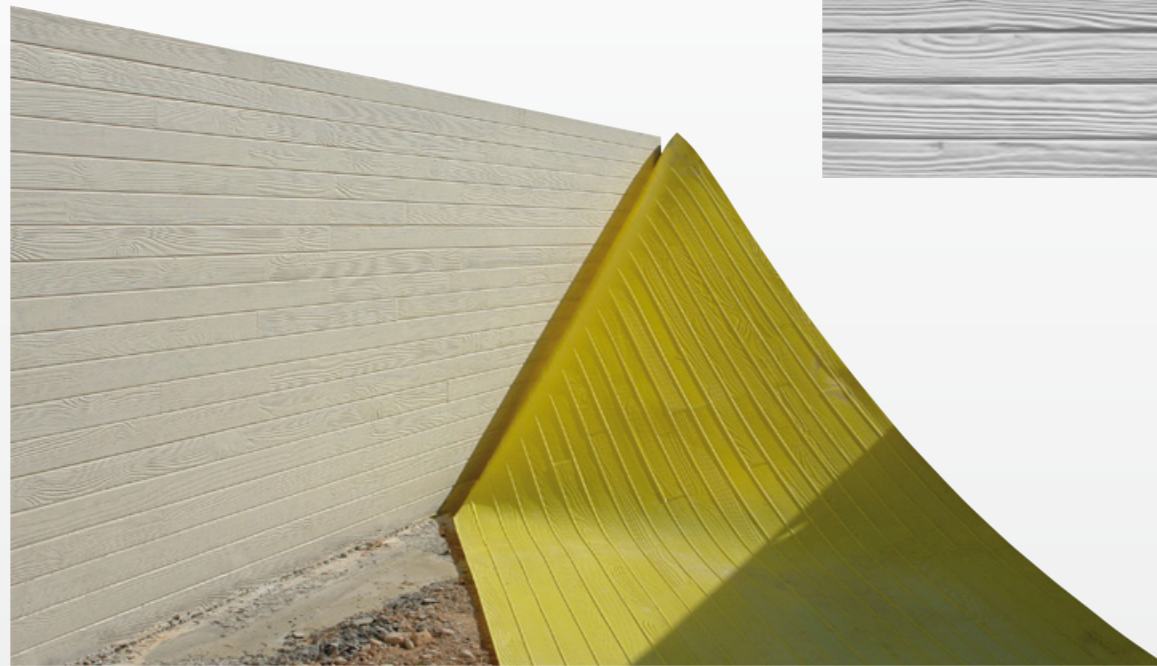
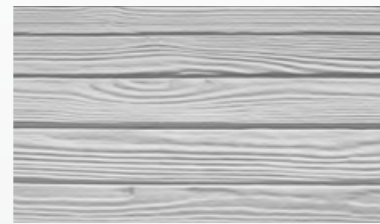

Wood collection

Dettaglio del getto

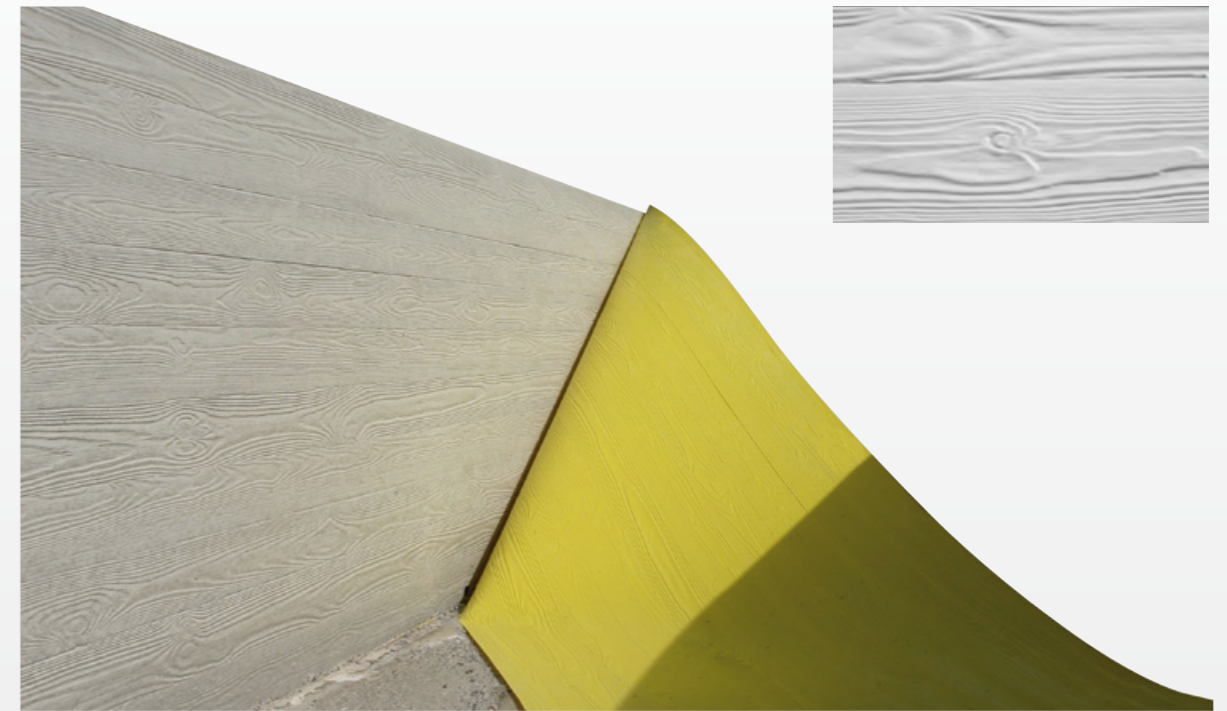
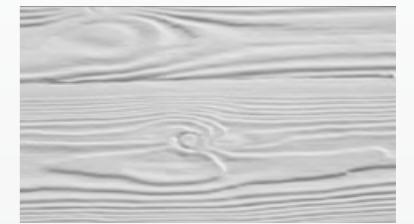

Wood collection

MOD. w06

MOD. w07

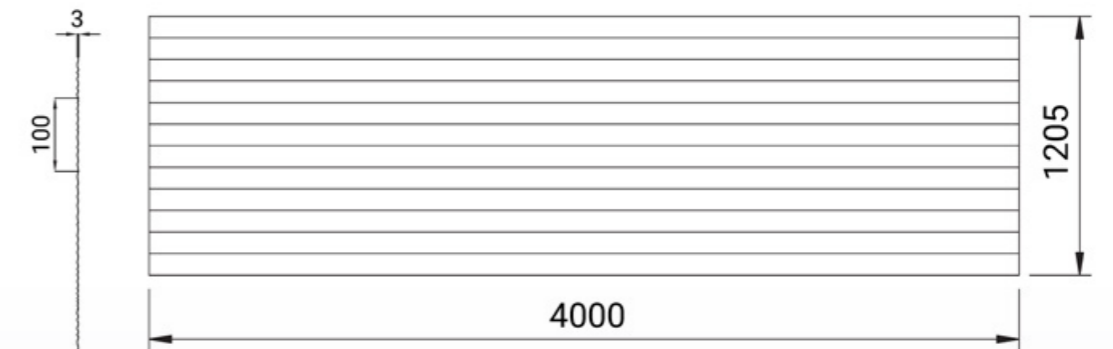
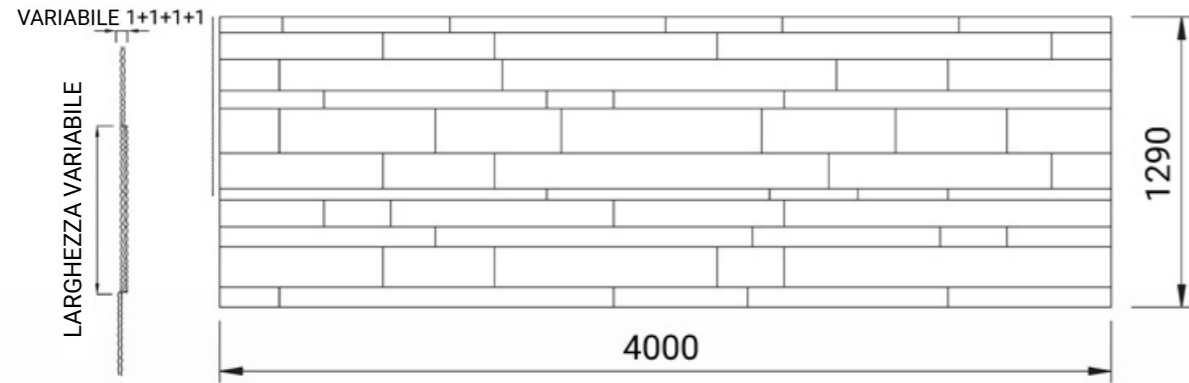

Dettaglio del getto

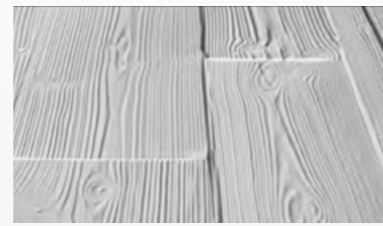

Dettaglio del getto

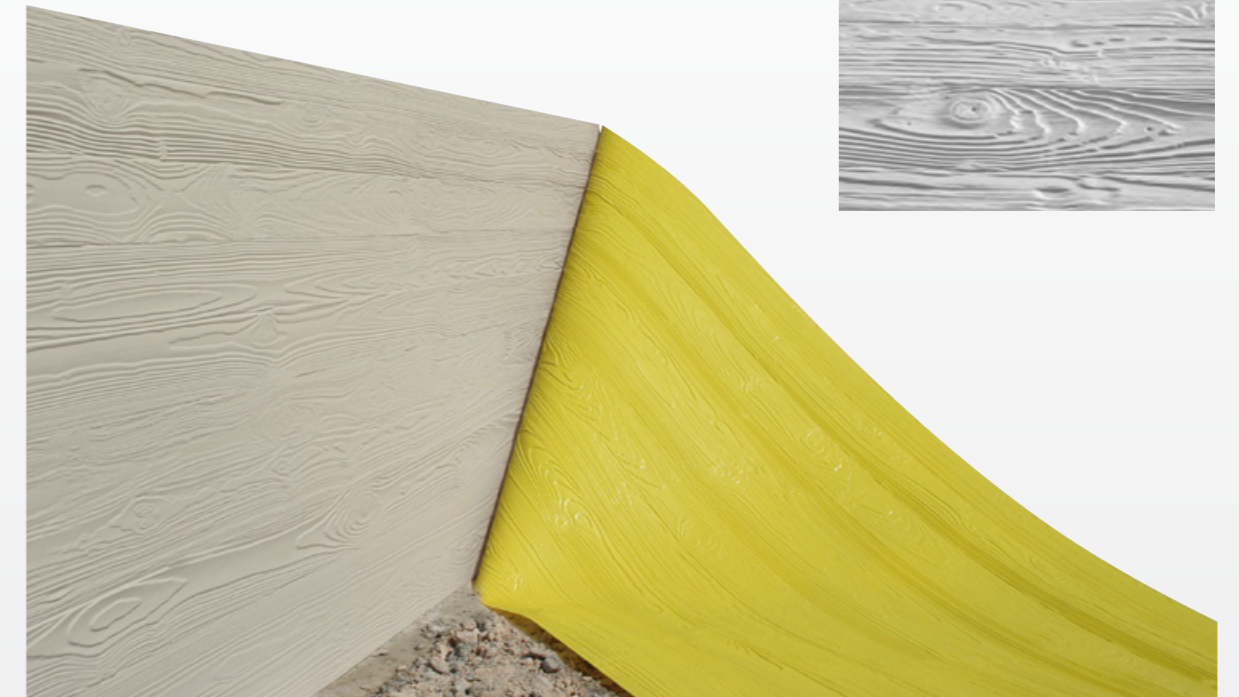
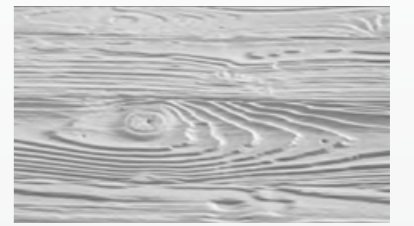

Wood collection

Wood collection



MOD. W08

MOD. W09

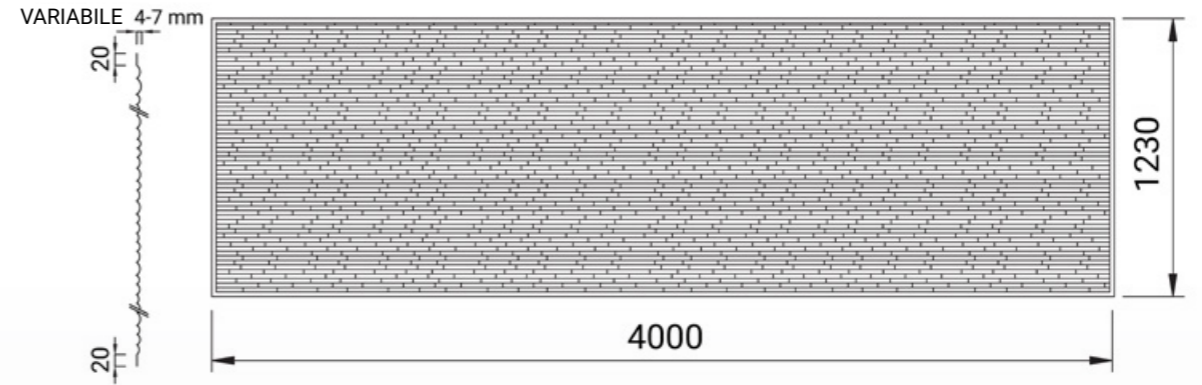
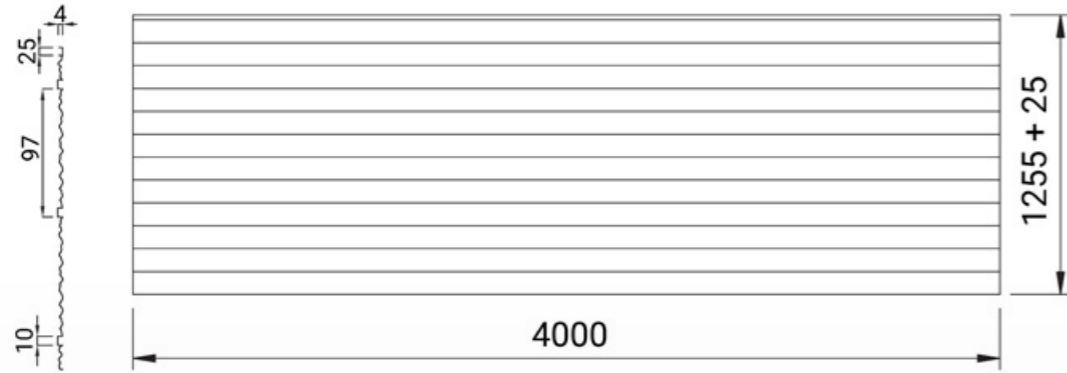

Dettaglio del getto

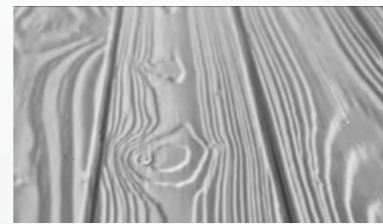

Dettaglio del getto

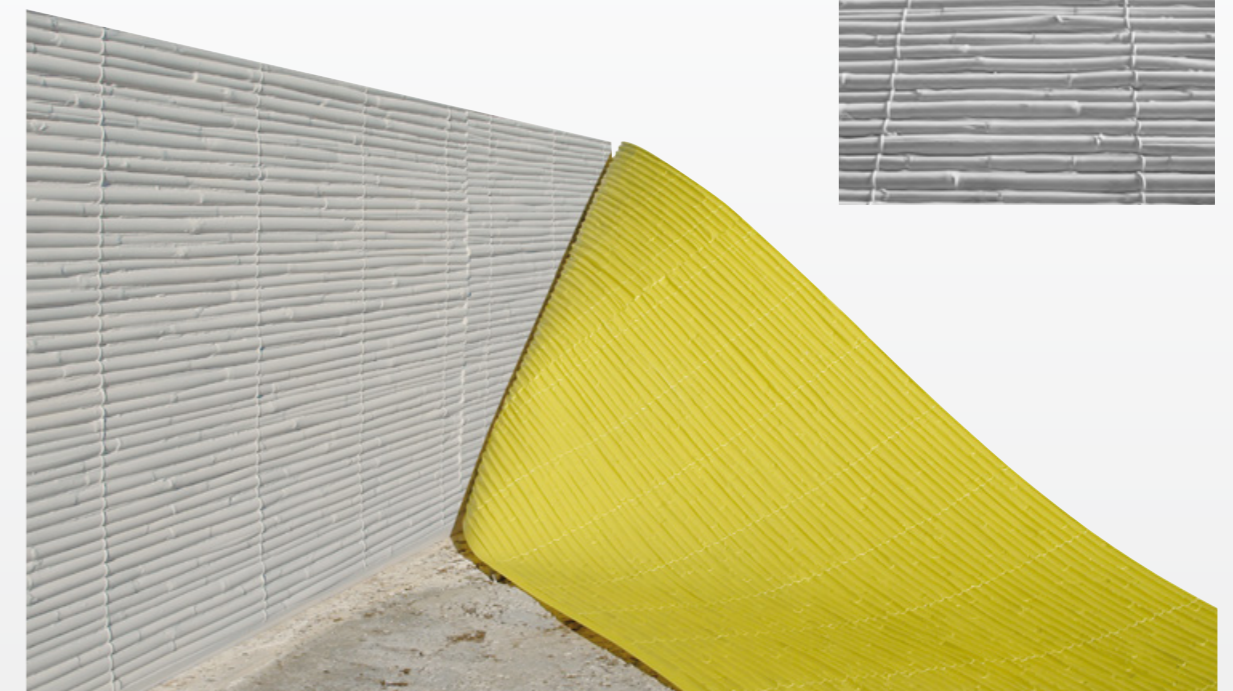
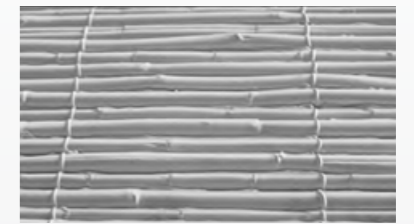

Wood collection

Wood collection

MOD. W11

MOD. W12

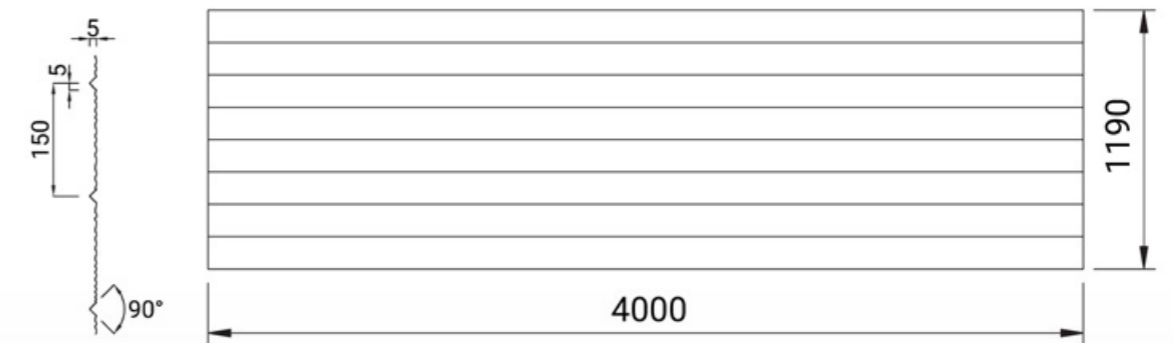
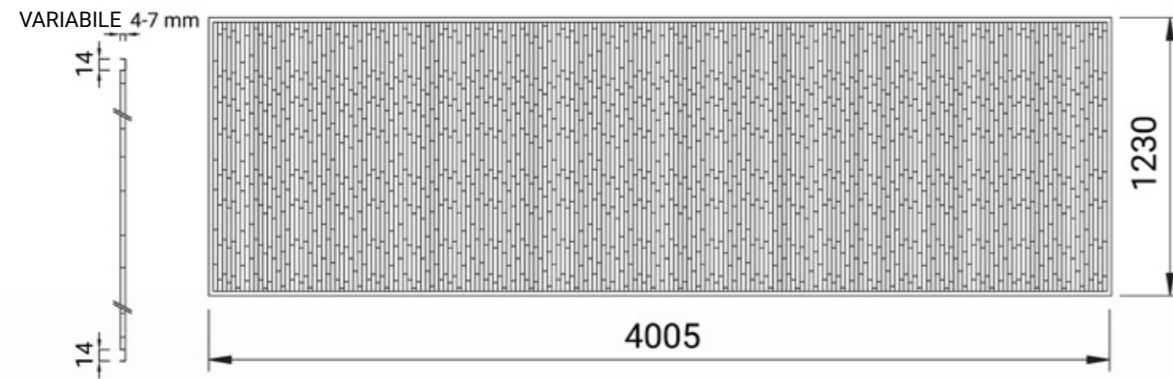

Dettaglio del getto

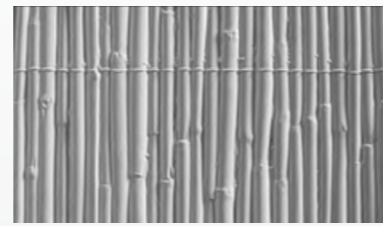

Dettaglio del getto

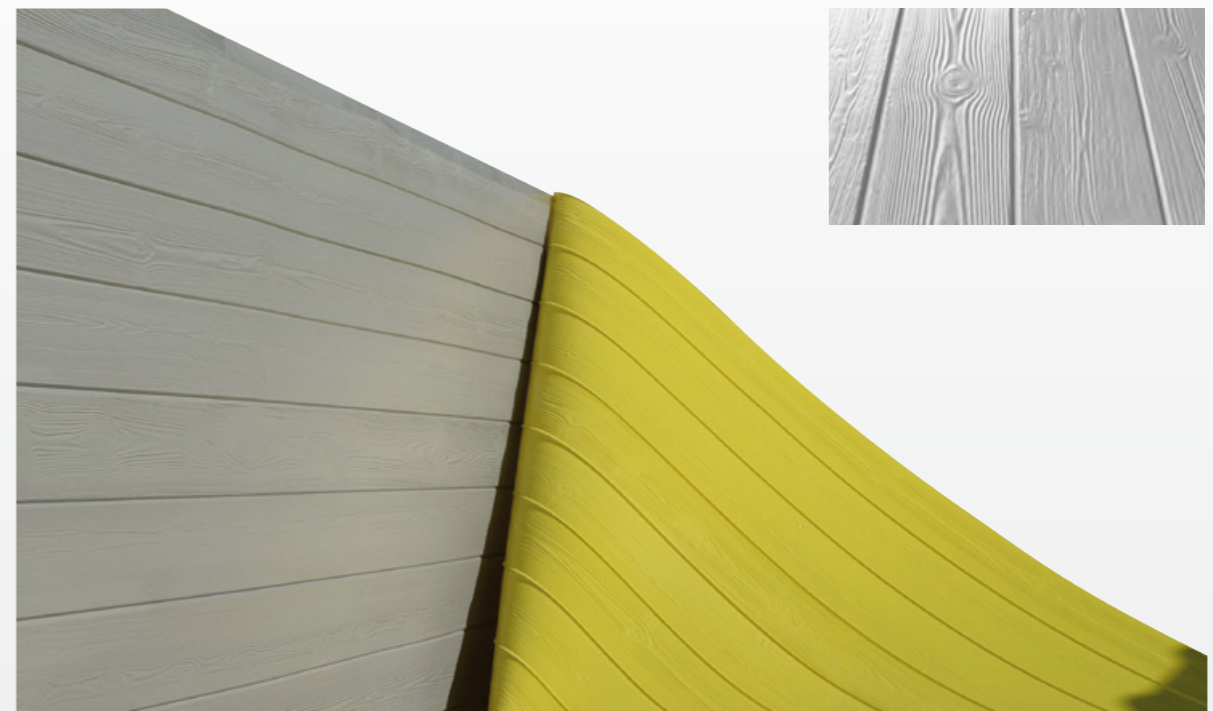
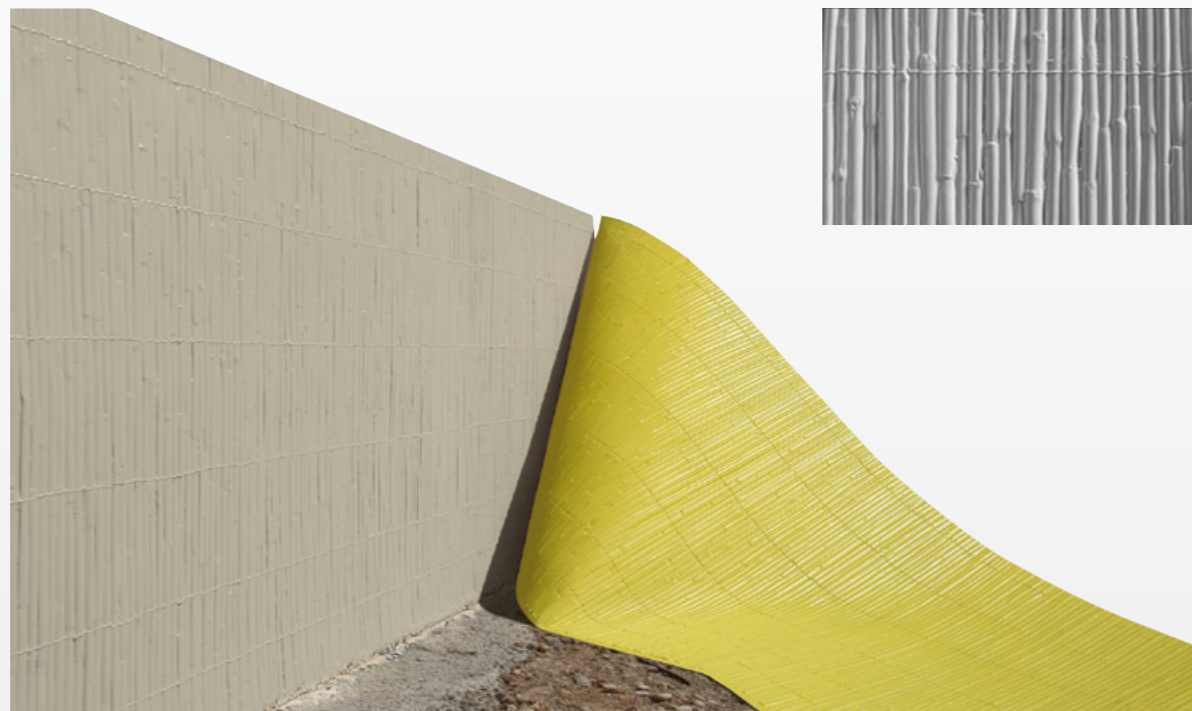
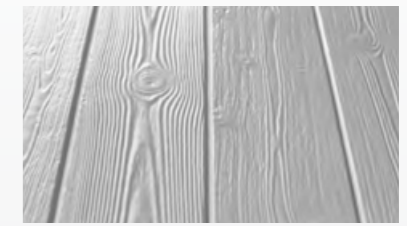

Wood collection

Wood collection



MOD. w14

MOD. w15

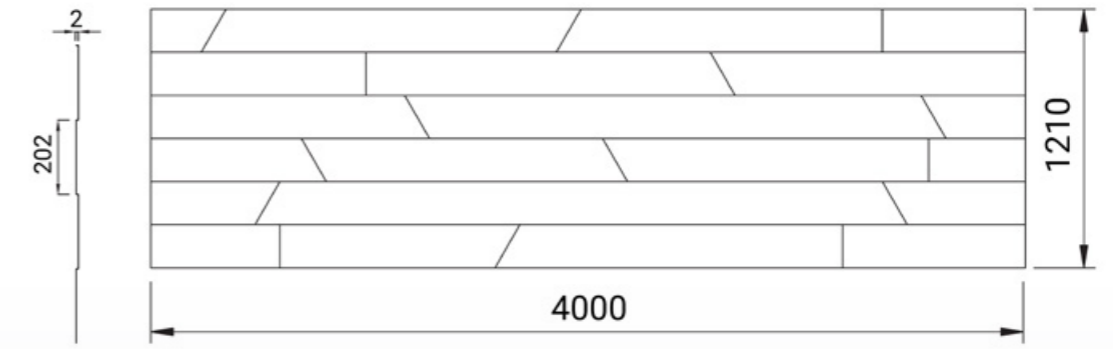
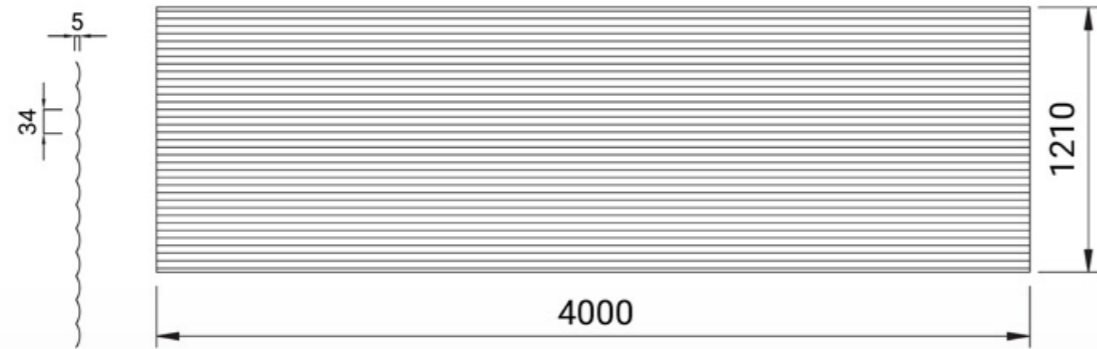

Dettaglio del getto

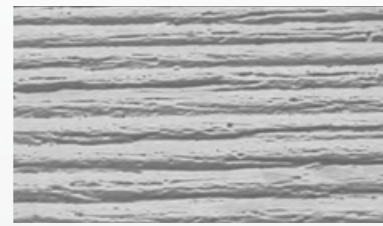

Dettaglio del getto

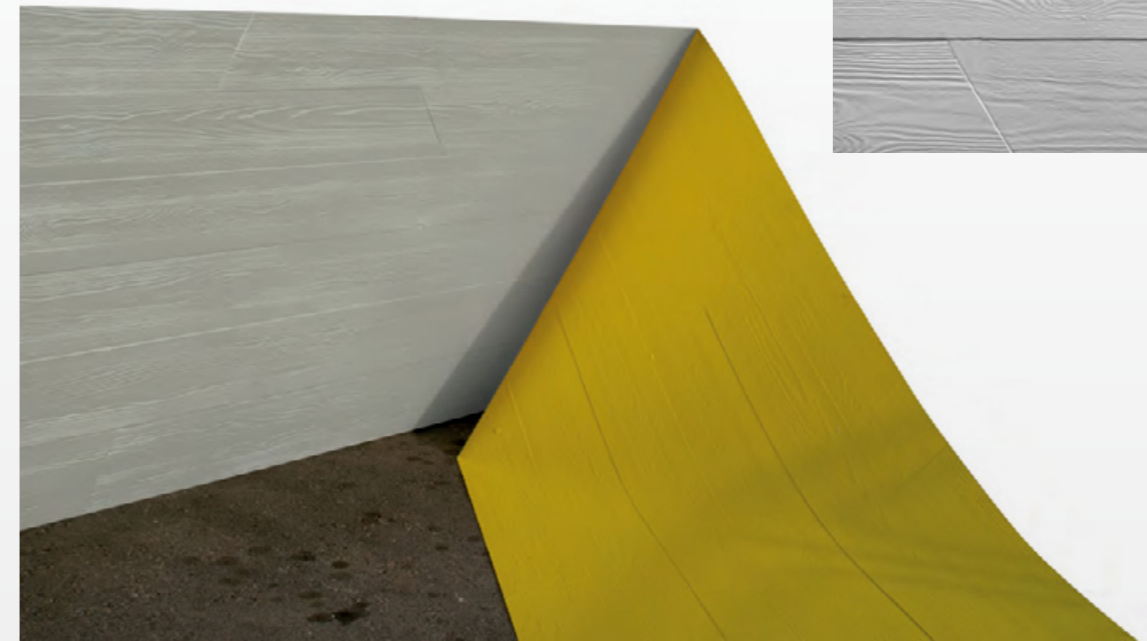
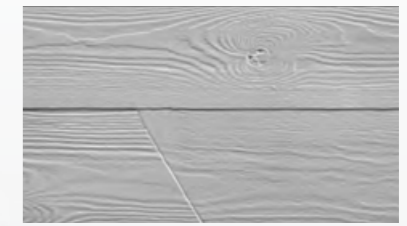

Wood collection

Wood collection

MOD. w74

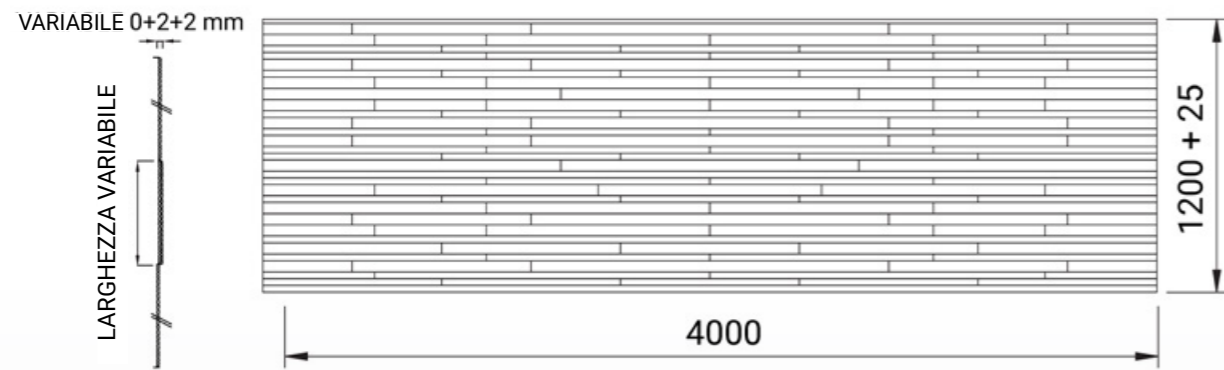

Dettaglio del getto

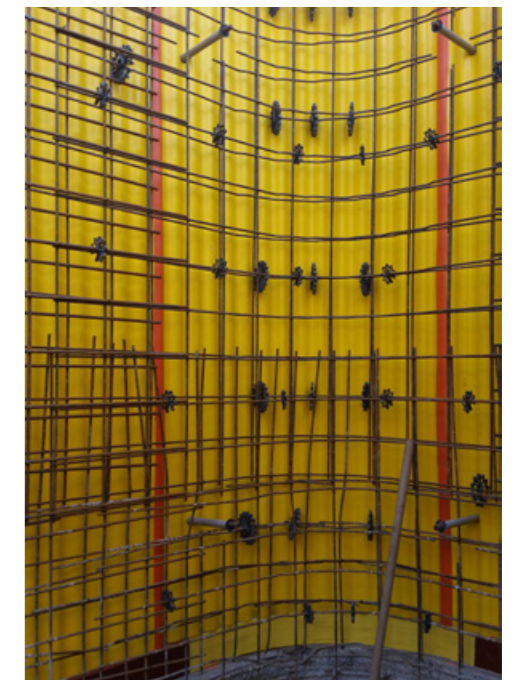
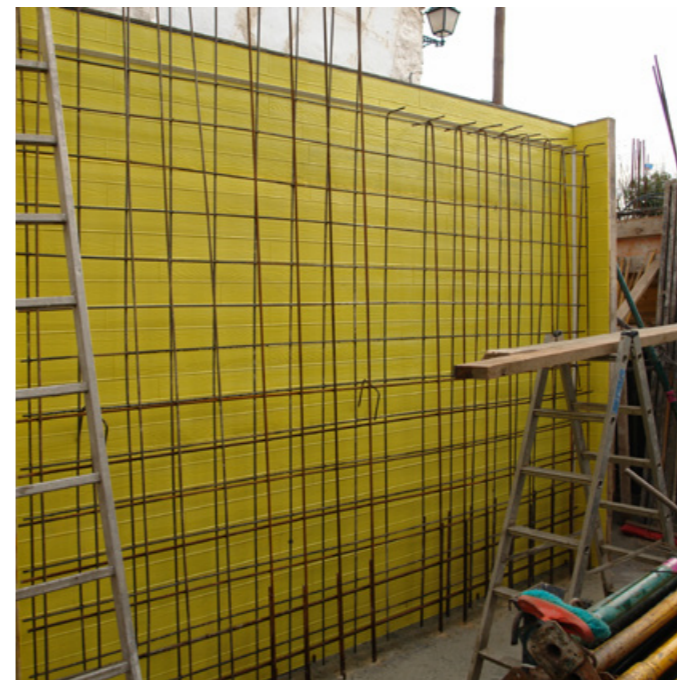
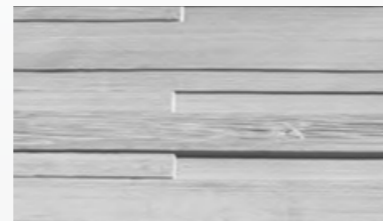

Wood collection



MOD. F21

MOD. F22

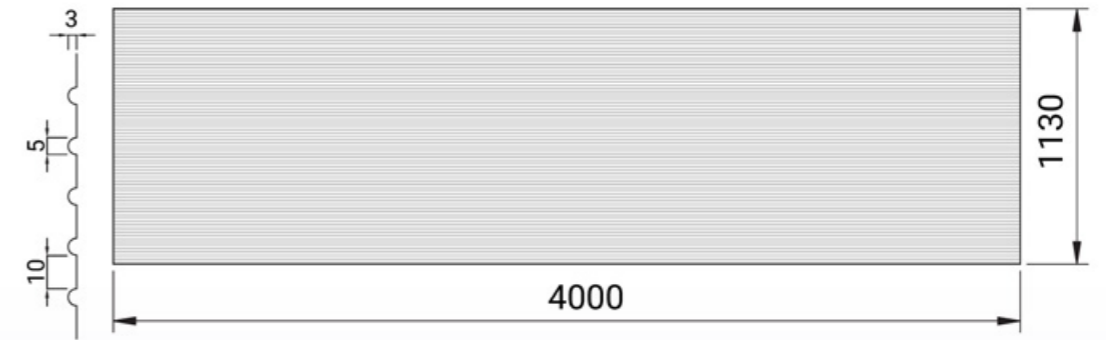
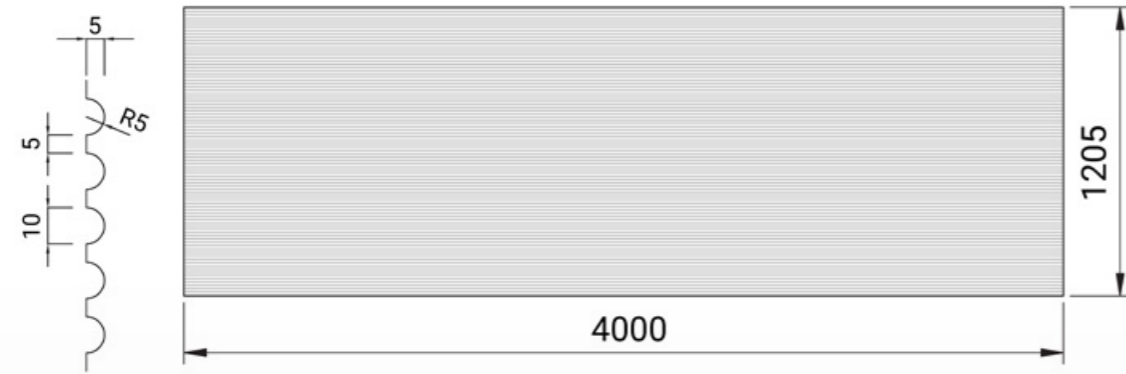

Dettaglio del getto

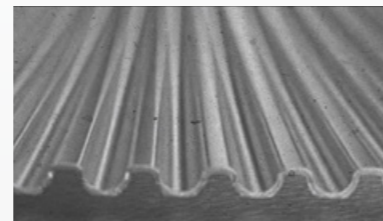

Dettaglio del getto

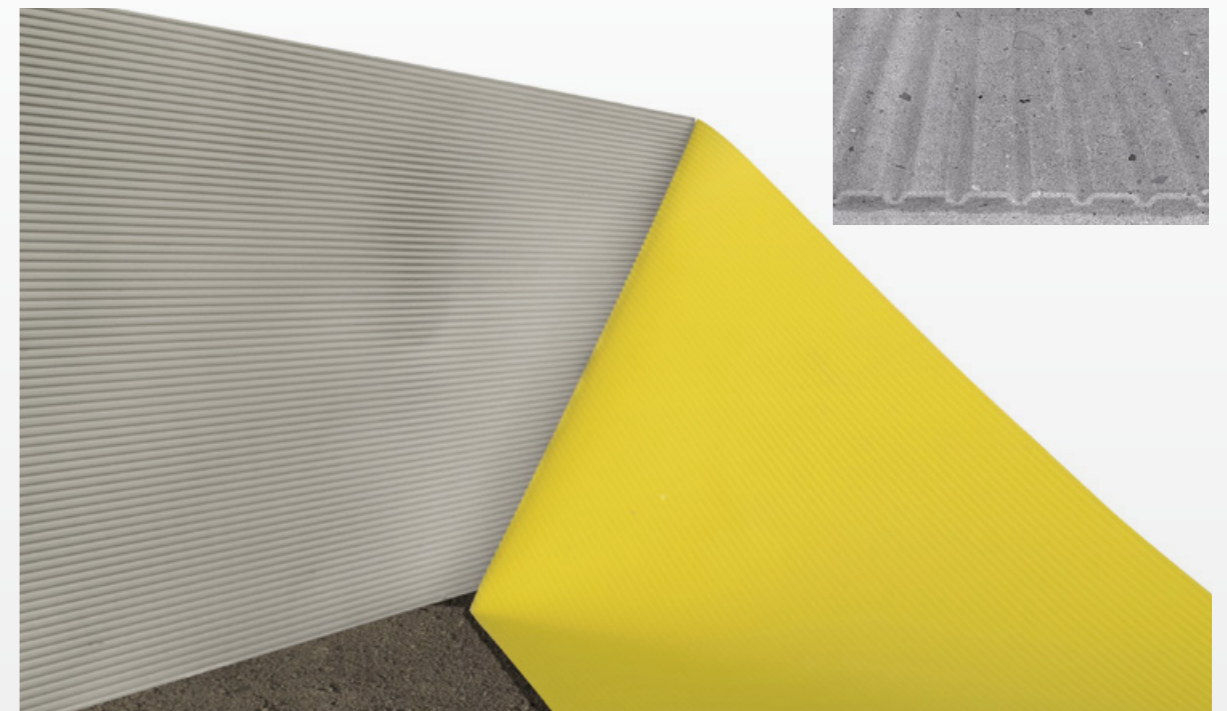
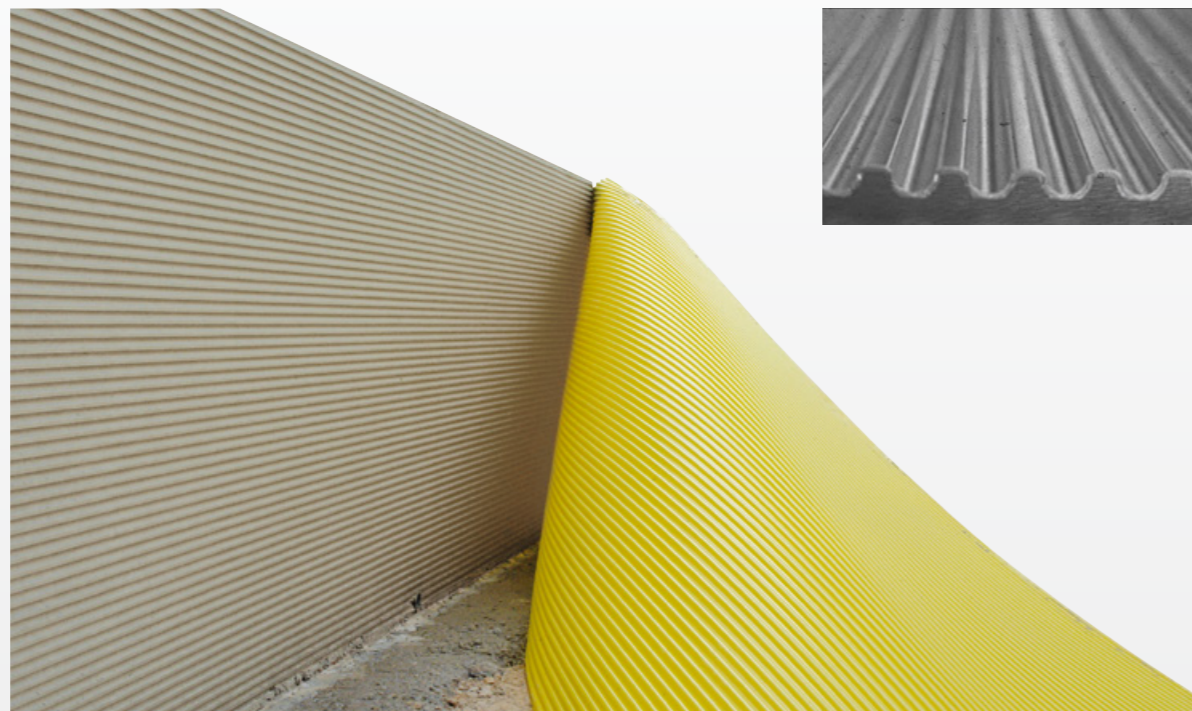
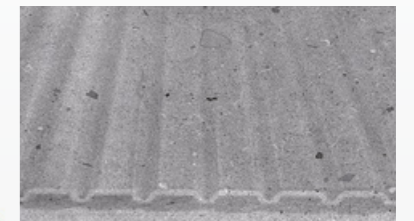

Form collection

Form collection



MOD. F23

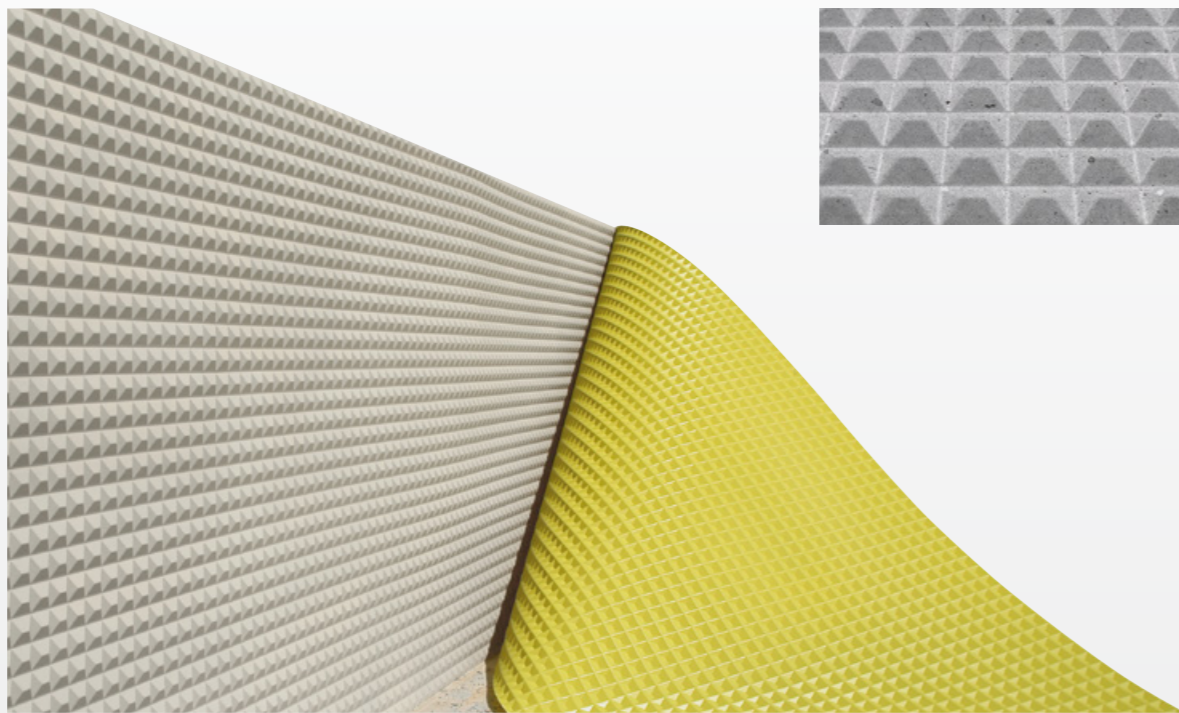
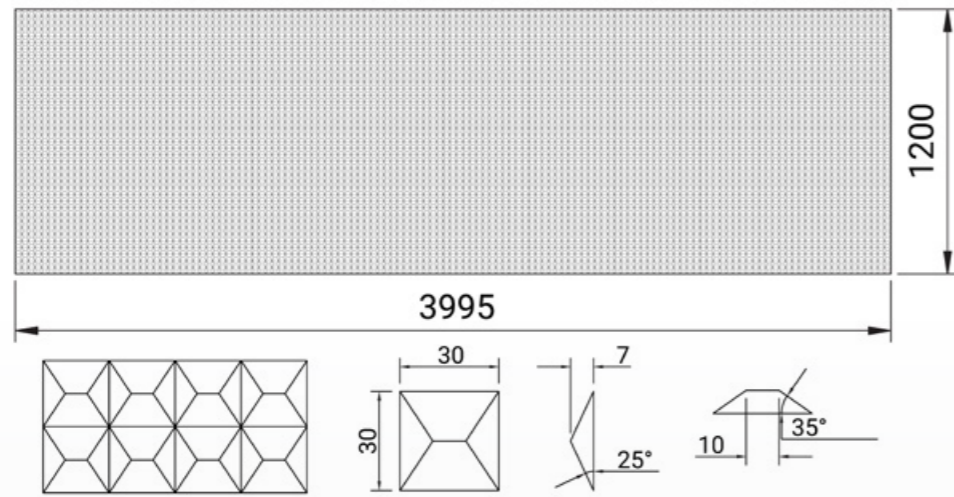

Form collection

MOD. F28

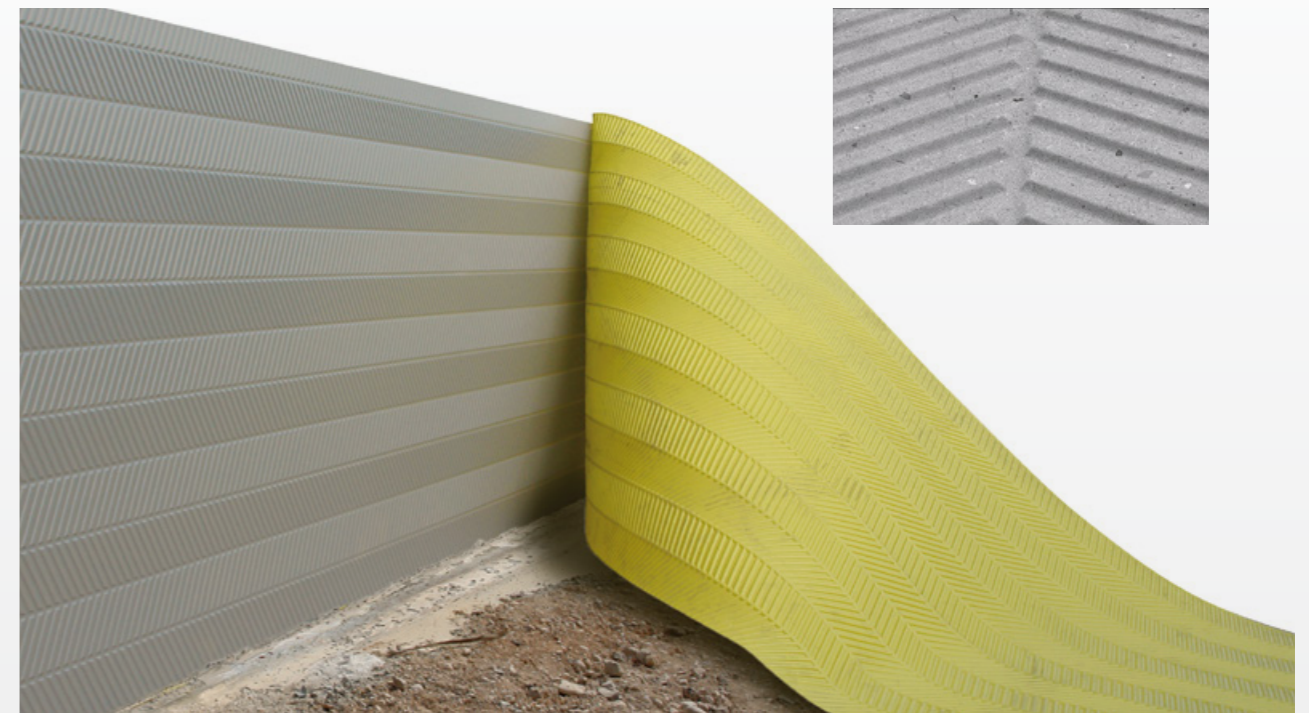
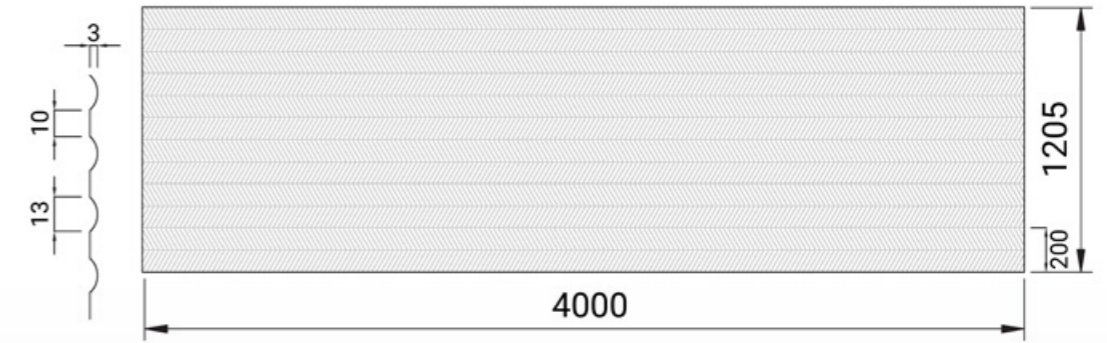

Form collection



MOD. F29

MOD. F30

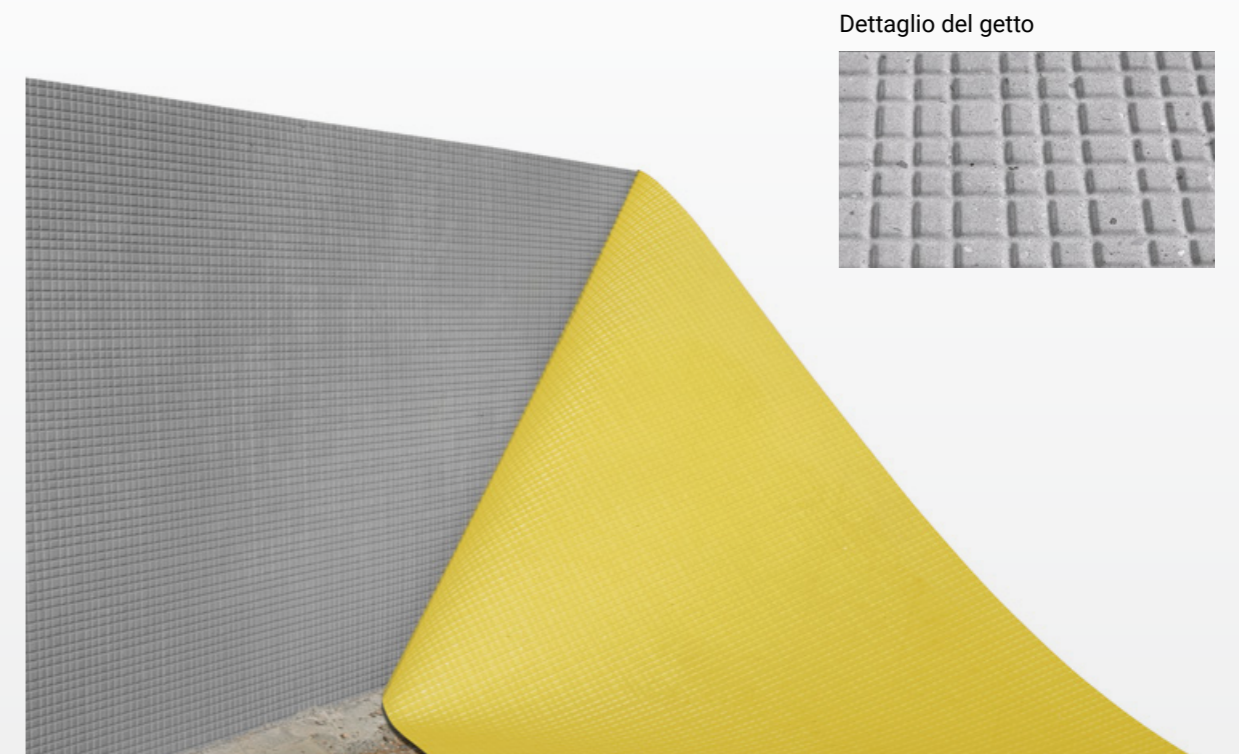
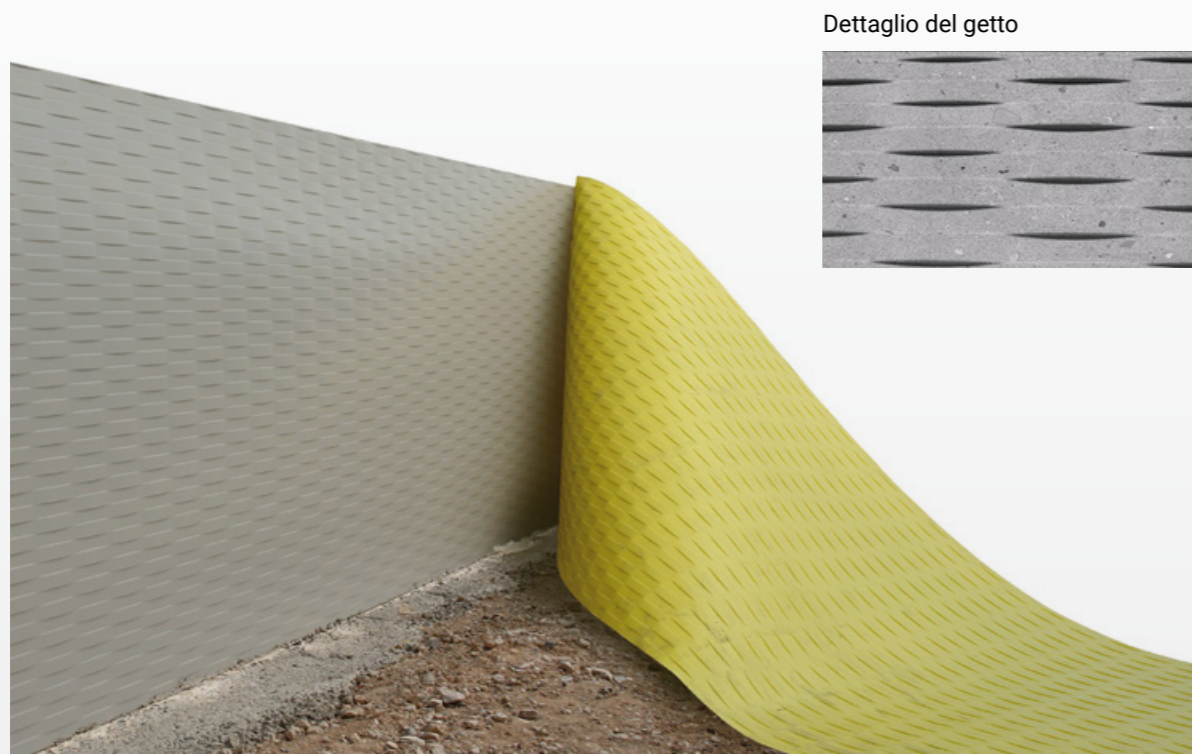
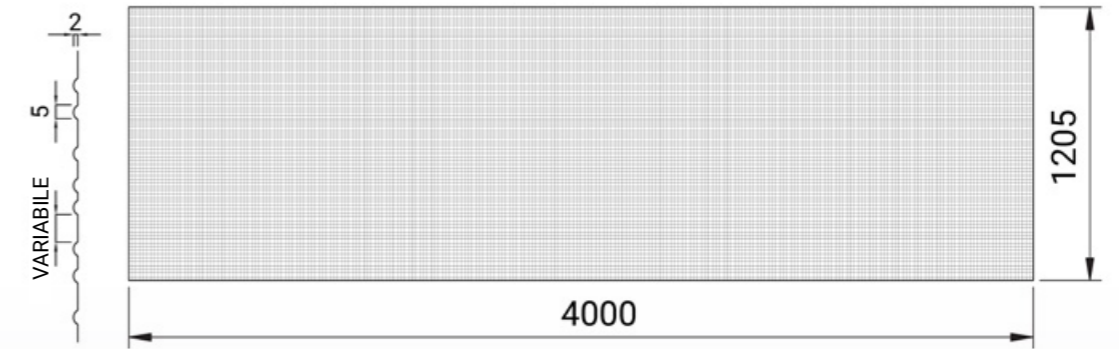
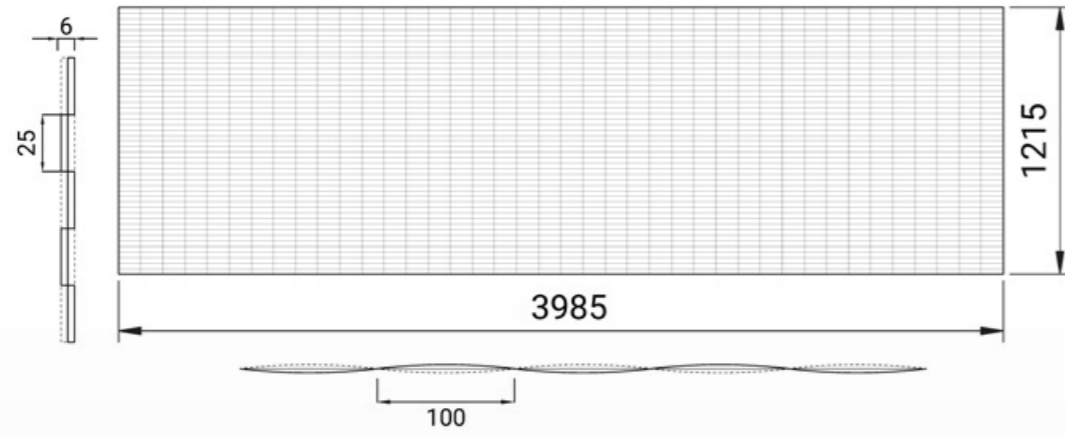

Form collection

Form collection

MOD. F31

MOD. F32

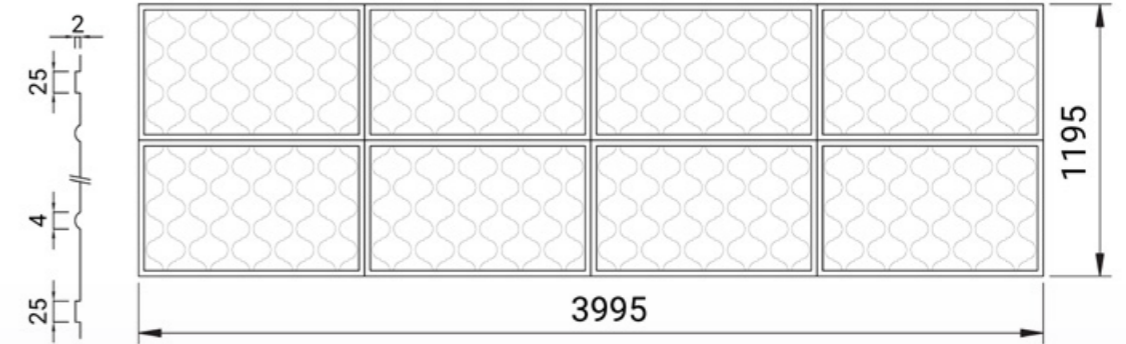
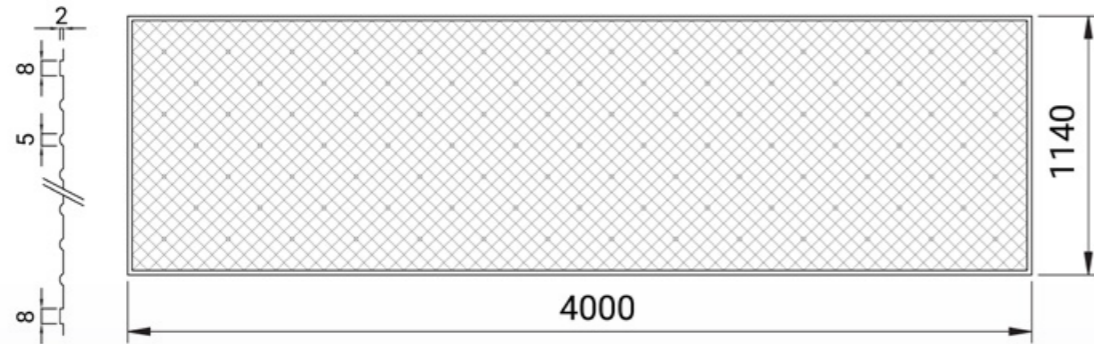

Dettaglio del getto



Dettaglio del getto

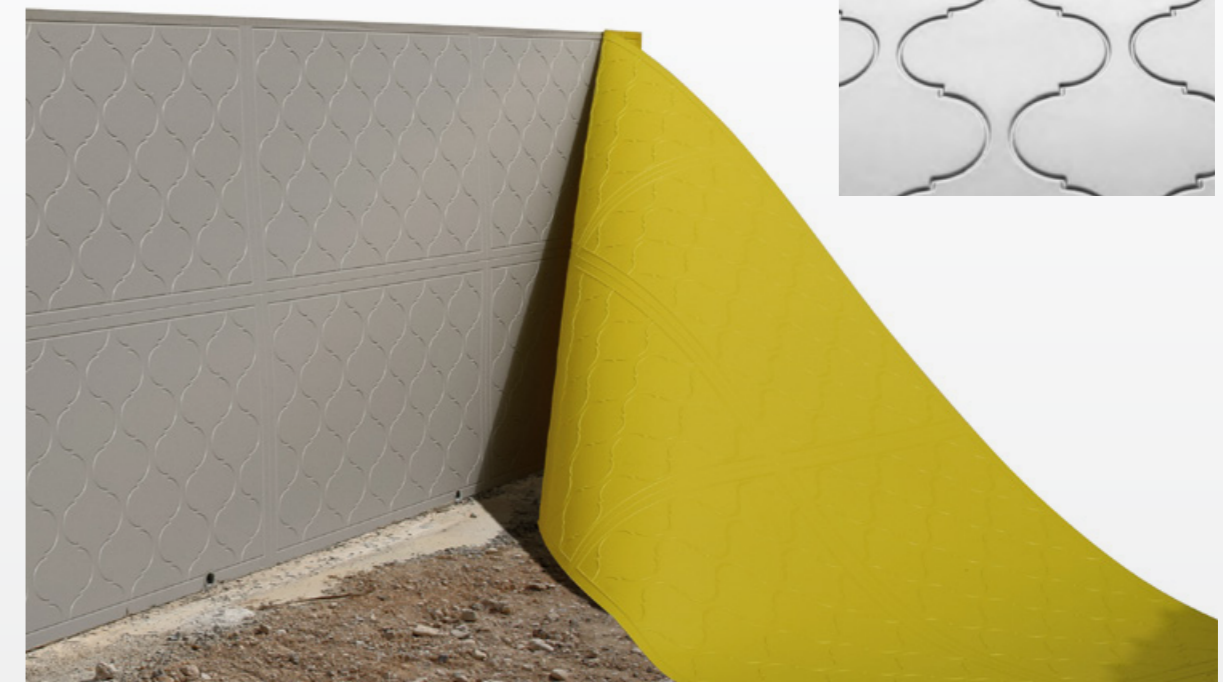
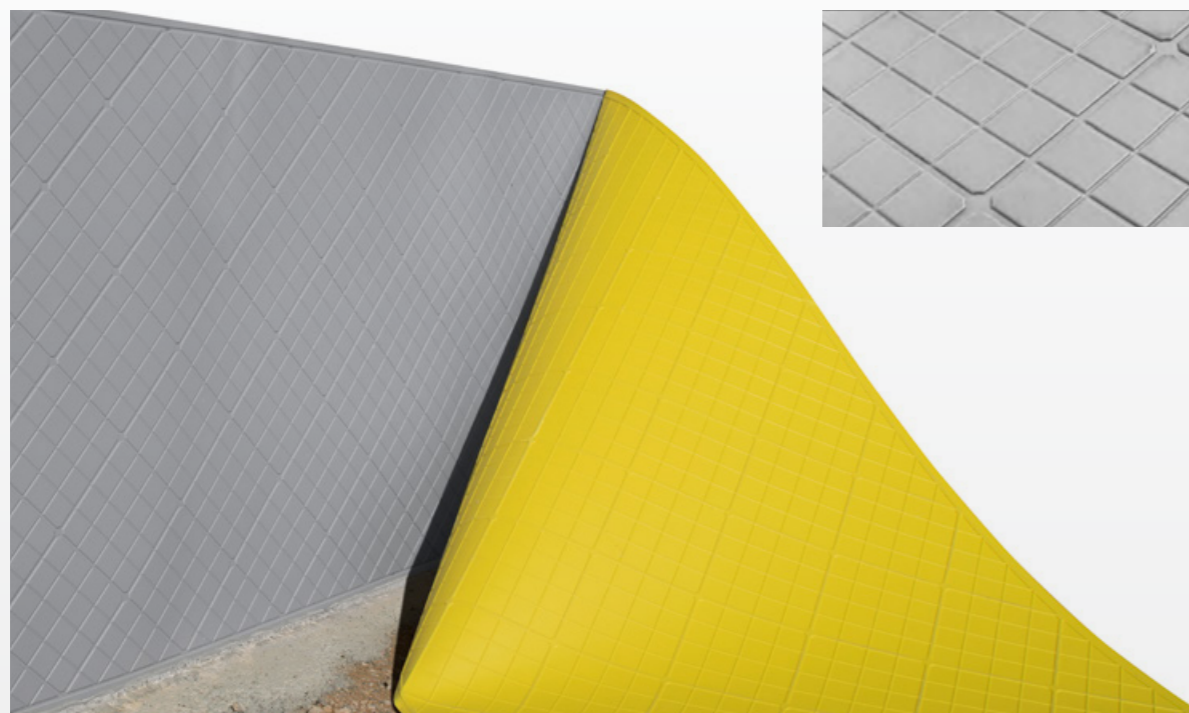

Form collection

Form collection



MOD. F33

MOD. F34

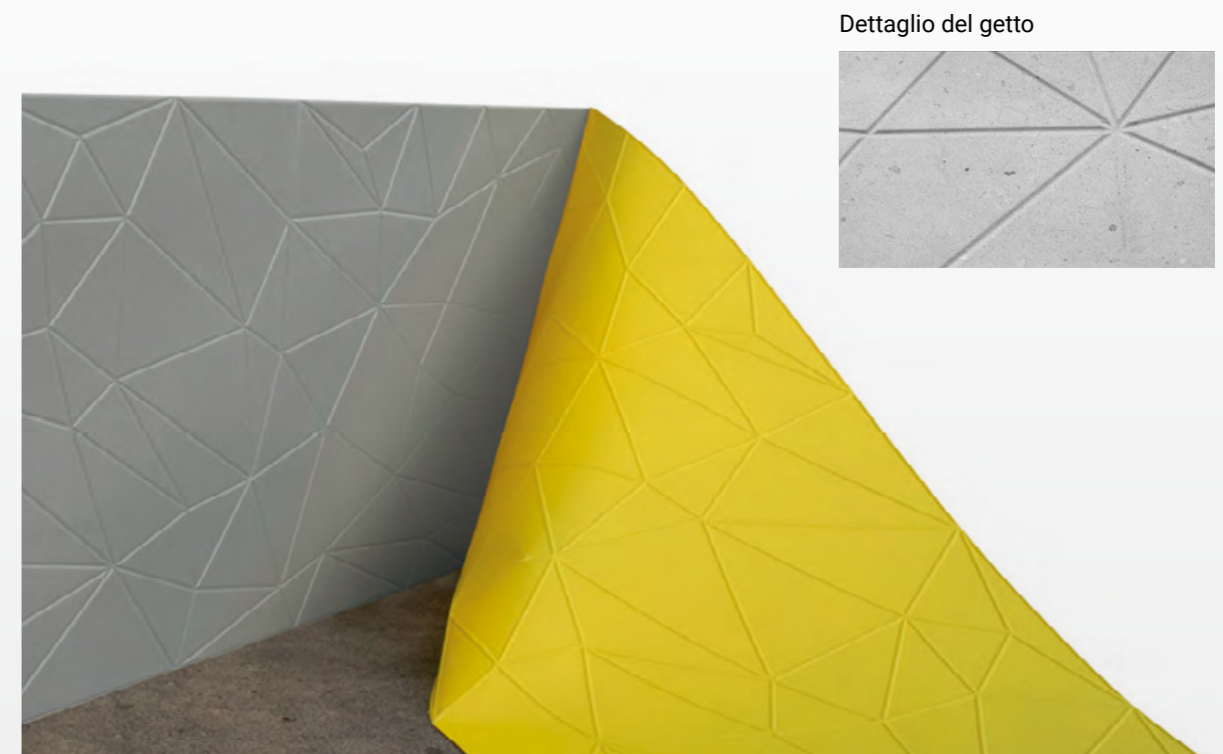
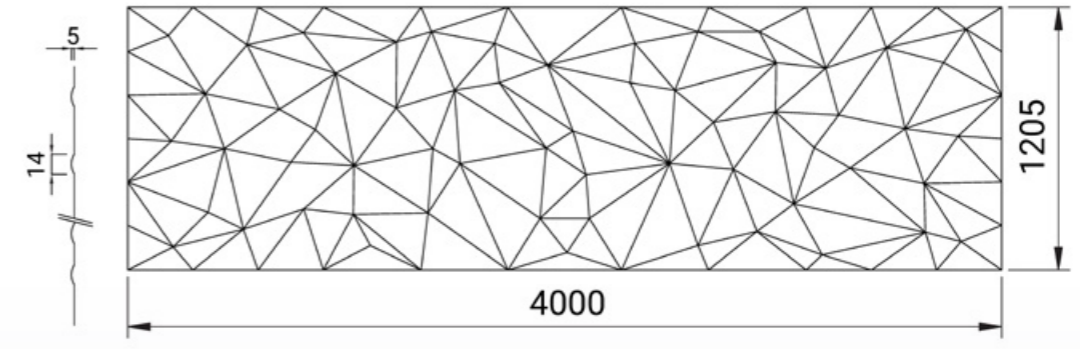
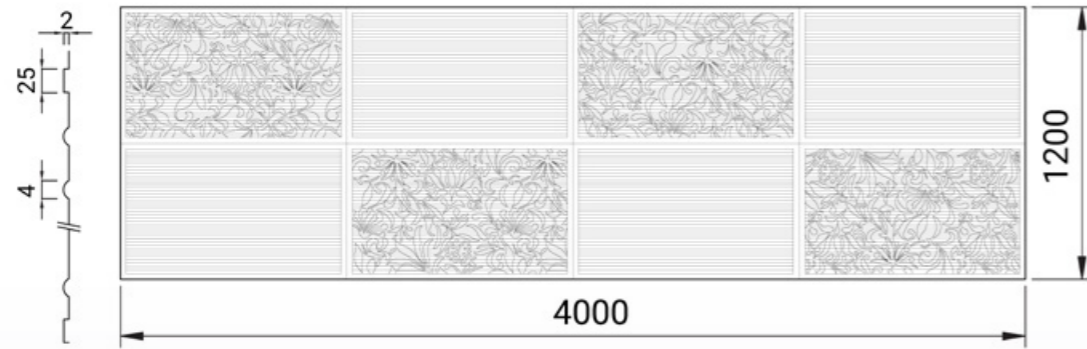

Form collection

Form collection

MOD. F35

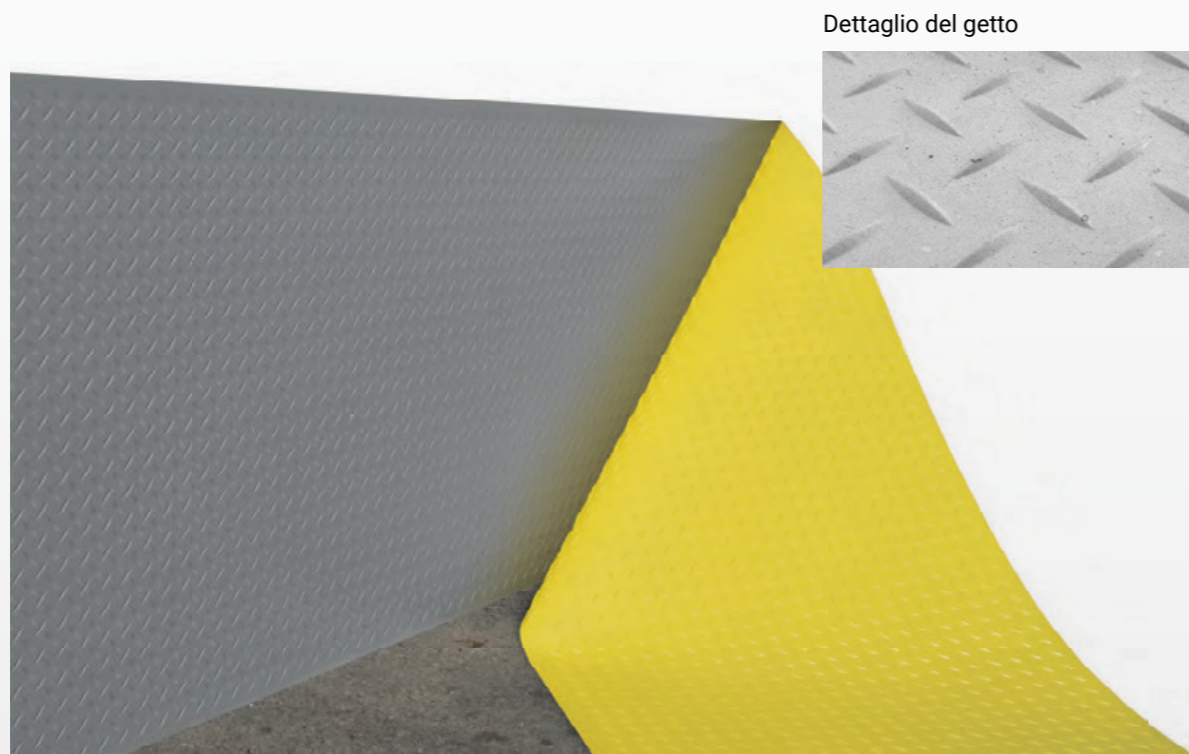
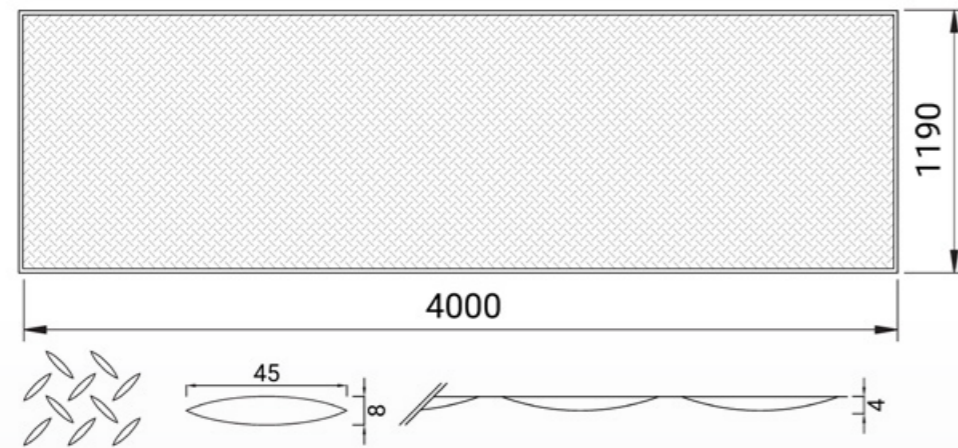

Form collection

MOD. F61

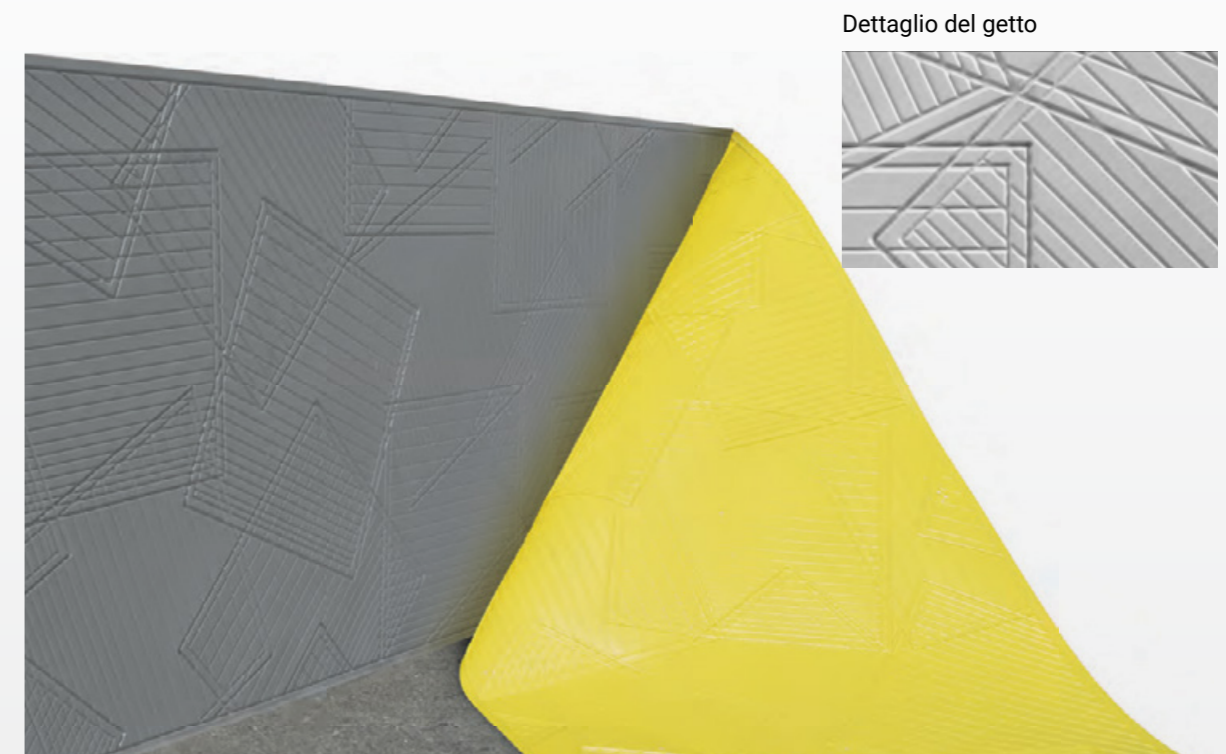
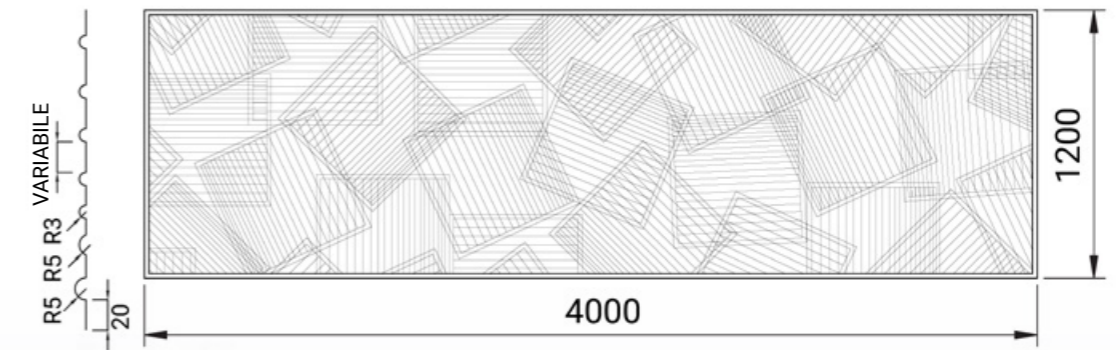

Form collection



MOD. F66

MOD. F75

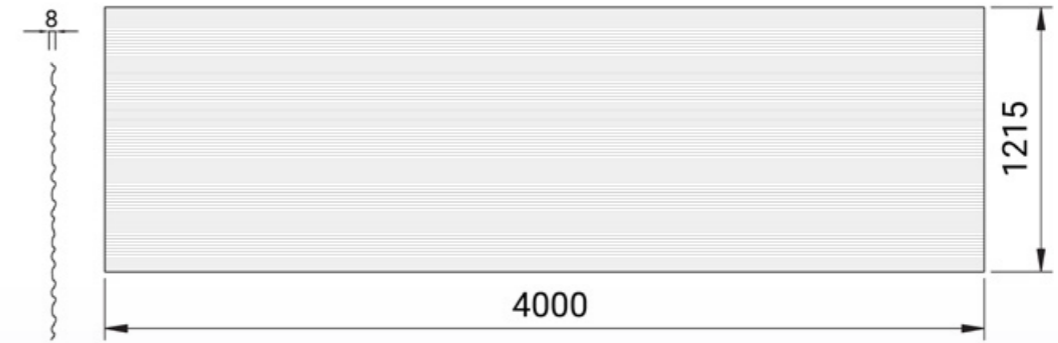
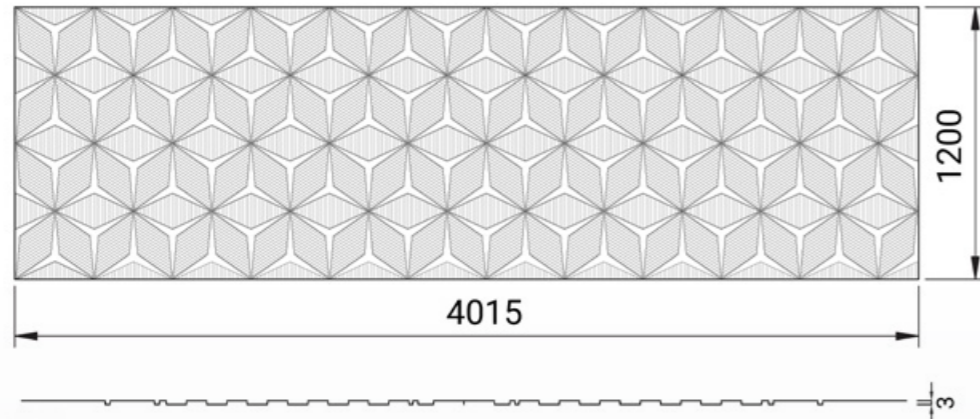

Dettaglio del getto



Dettaglio del getto

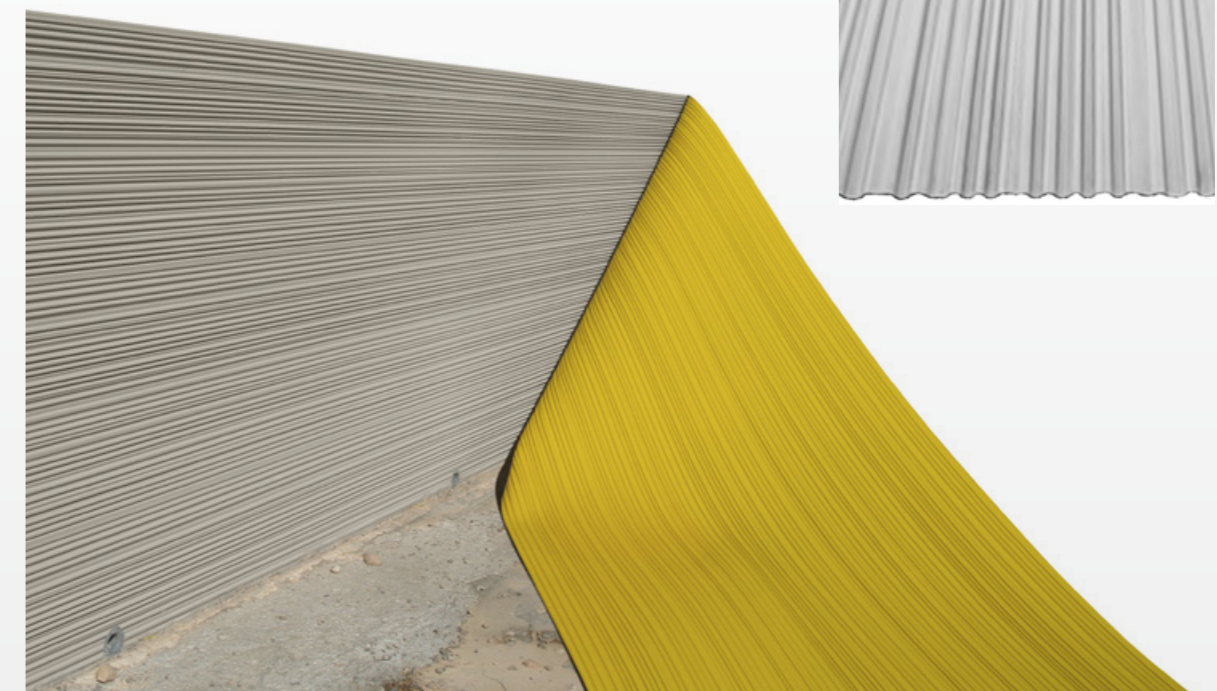
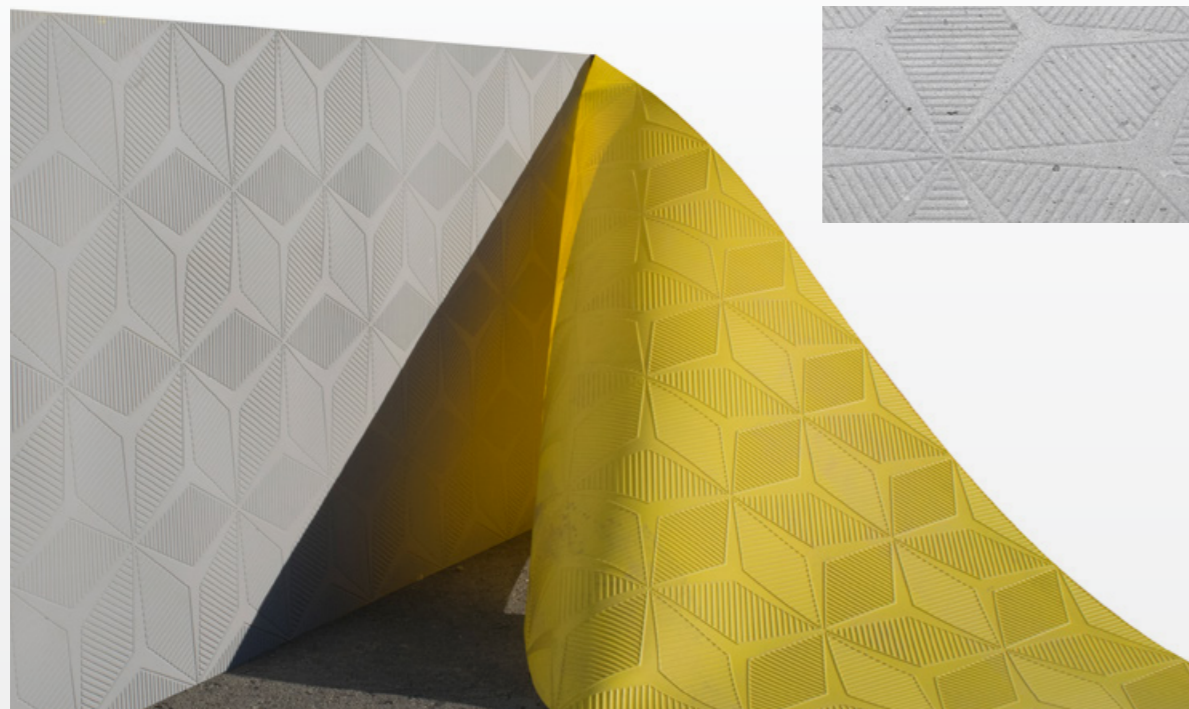
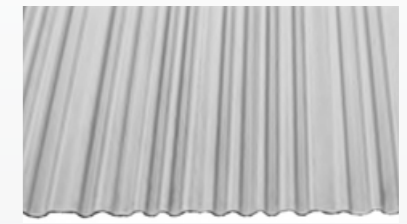

Form collection

Form collection

MOD. F77

MOD. F78

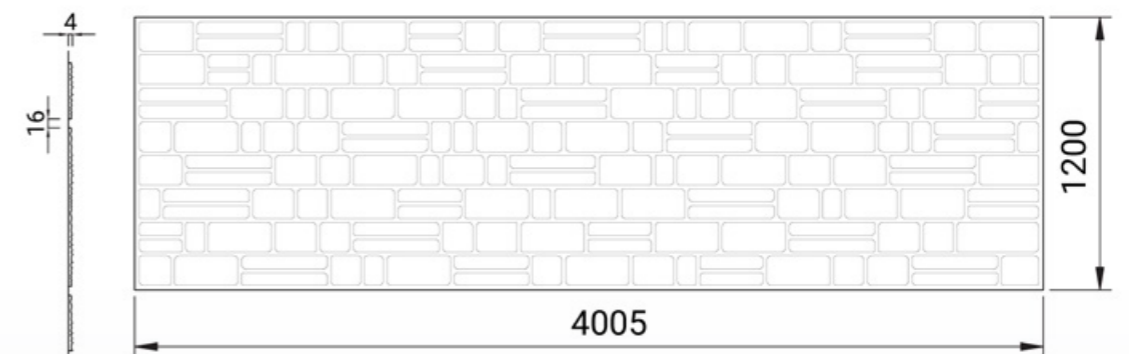
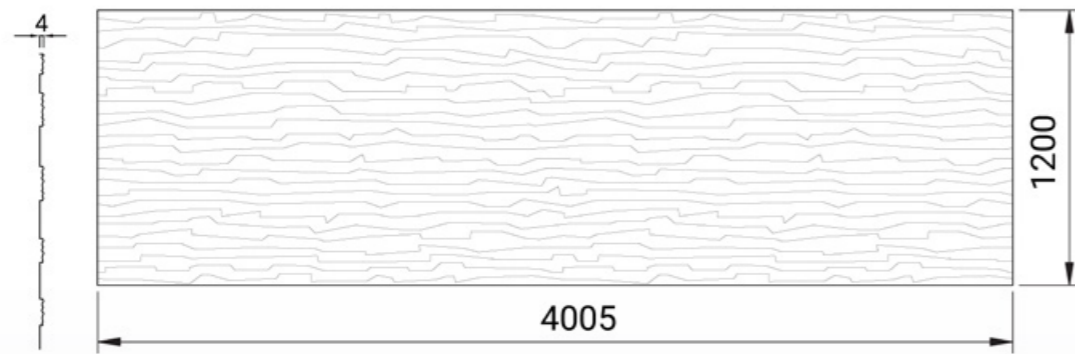

Dettaglio del getto

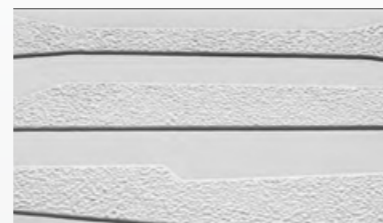

Dettaglio del getto

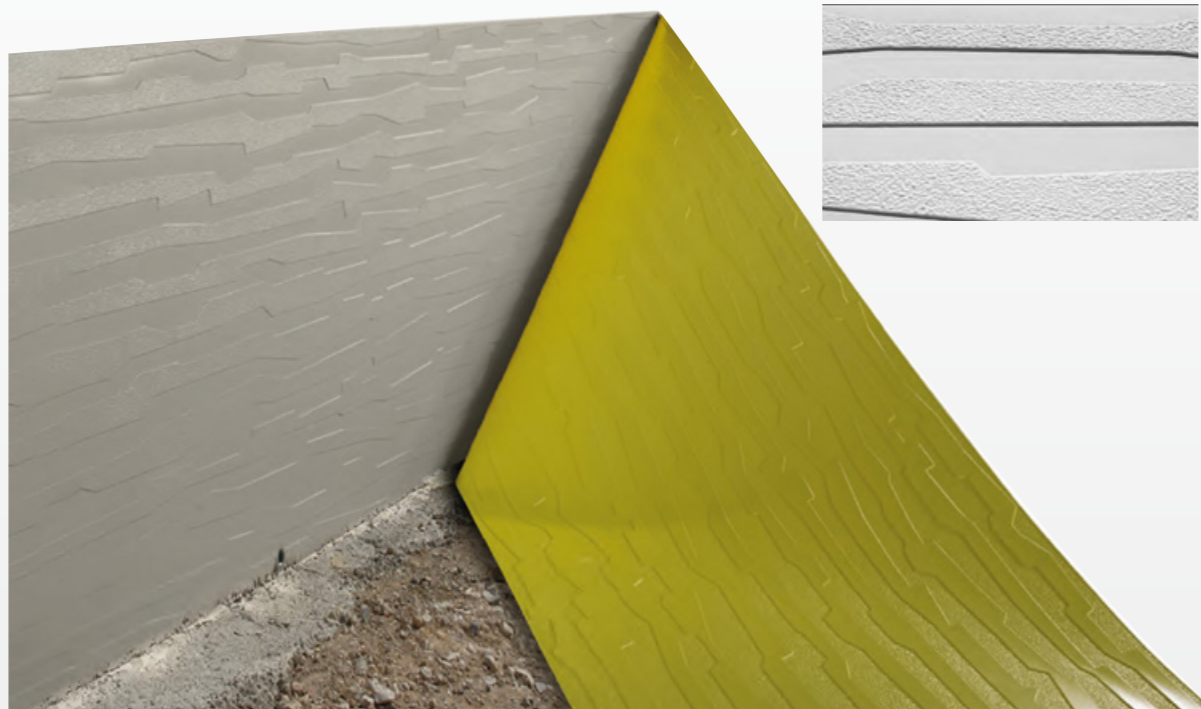

Form collection

Form collection



MOD. s51

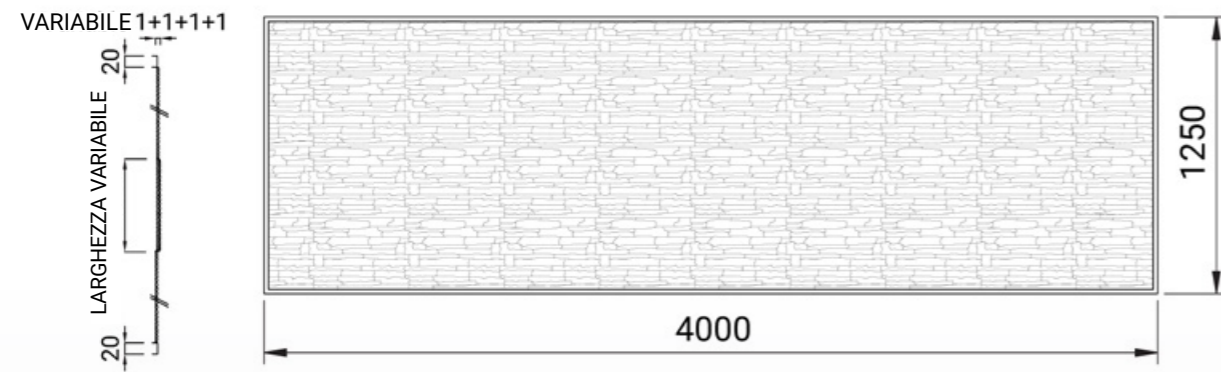

MOD. s53

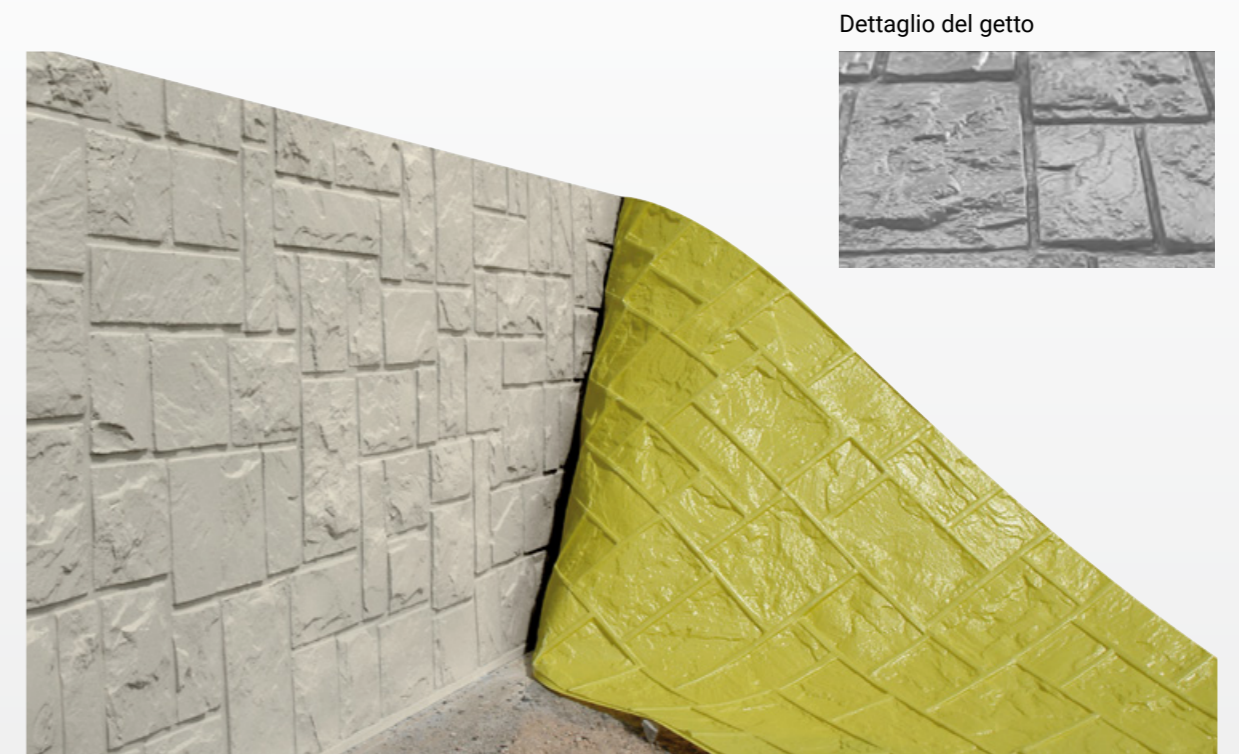
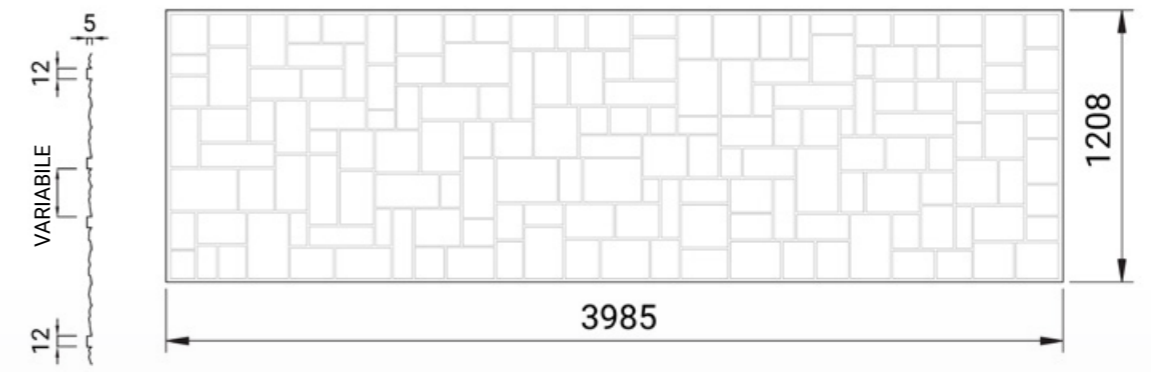

Stone collection

Stone collection

MOD. s54

MOD. s55

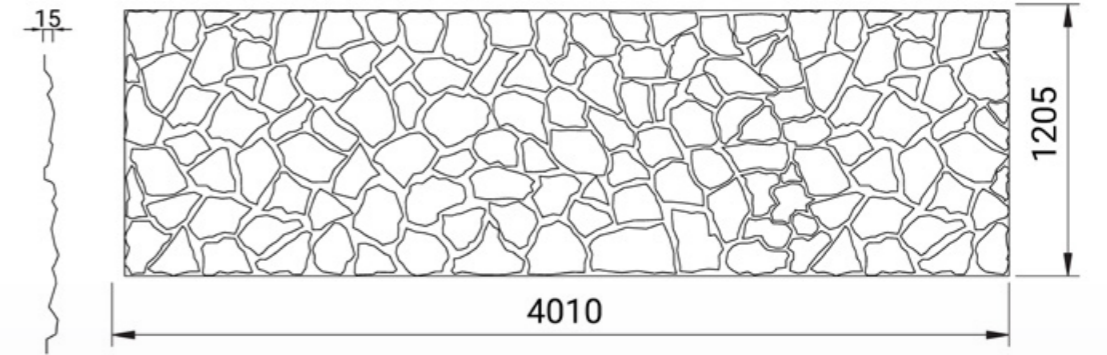
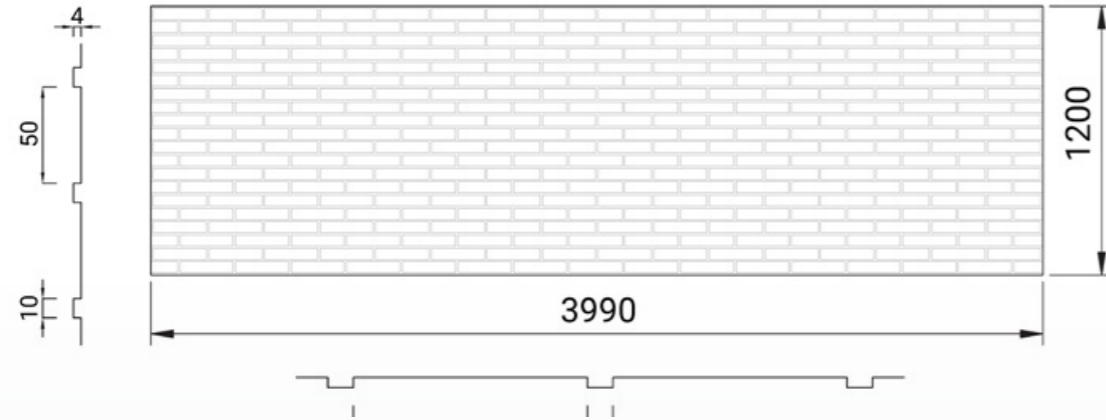

Dettaglio del getto

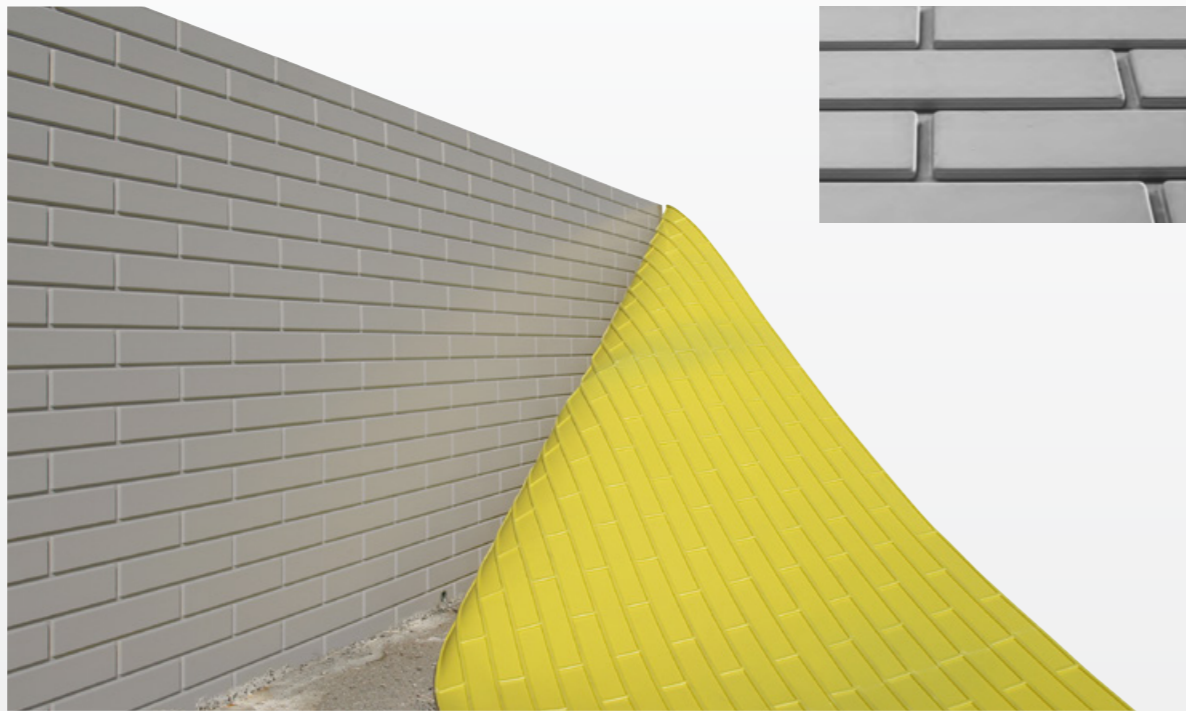

Stone collection

Dettaglio del getto

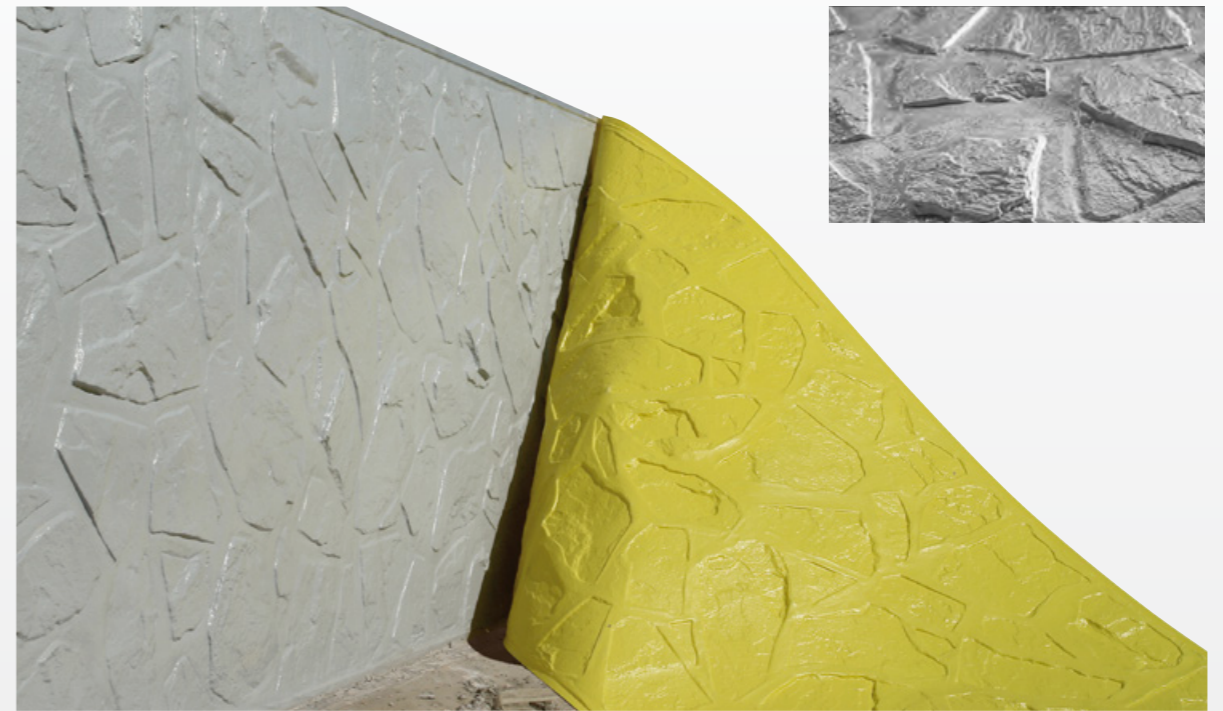

Stone collection



MOD. s56

MOD. s57

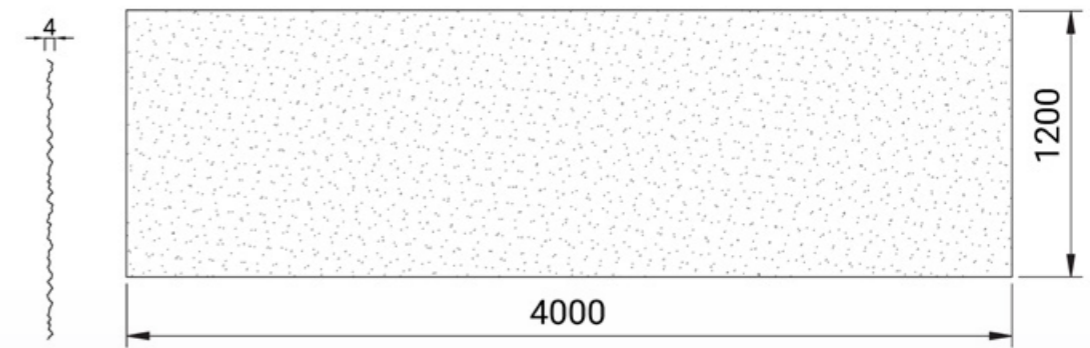
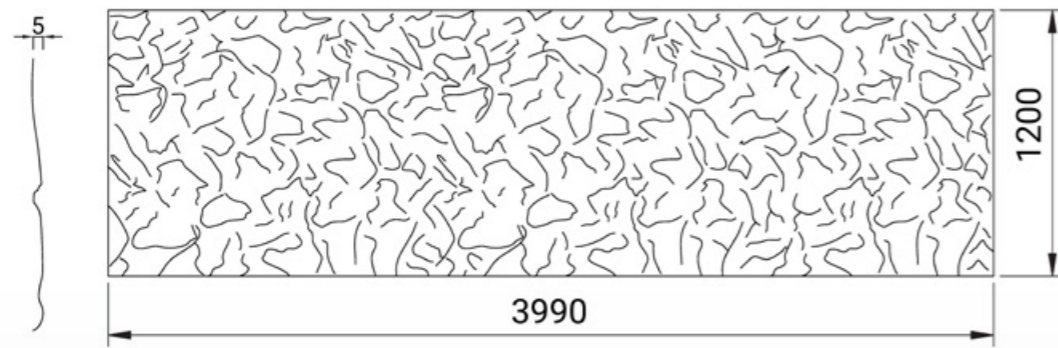

Dettaglio del getto

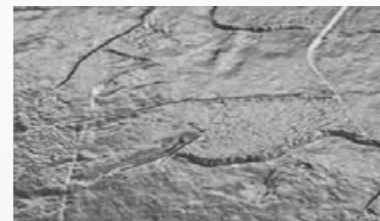

Dettaglio del getto



Stone collection

Stone collection

MOD. s58

MOD. s70

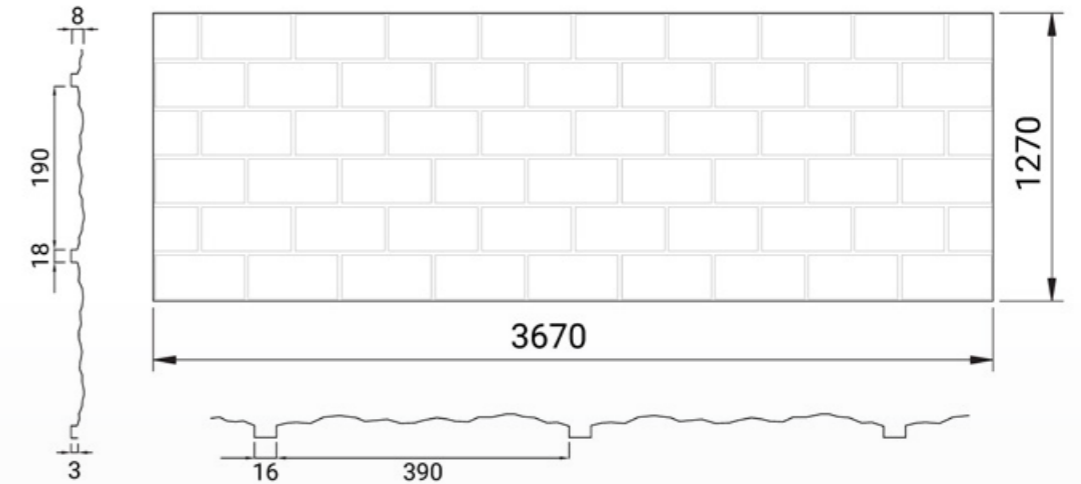
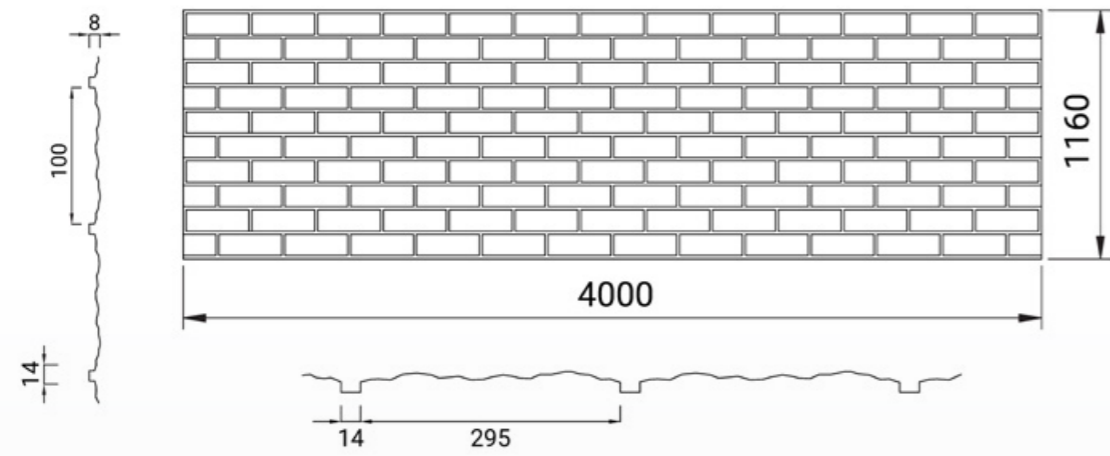

Dettaglio del getto

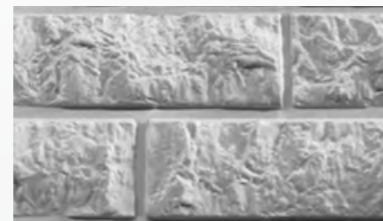

Dettaglio del getto

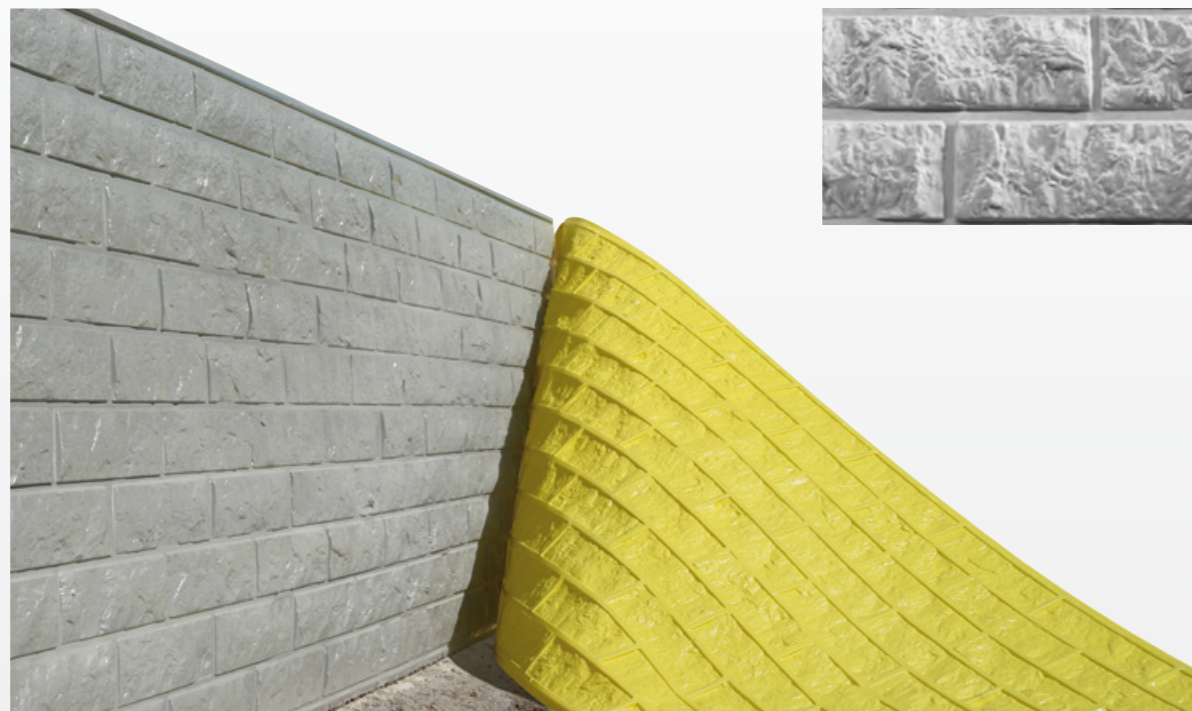
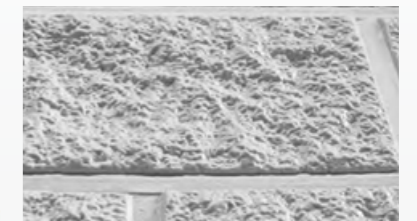

Stone collection

Stone collection



MOD. s76

MOD. s80

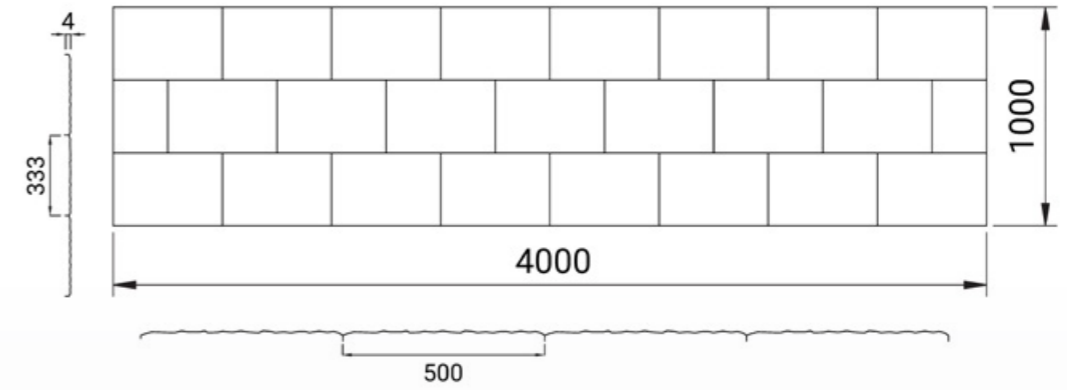
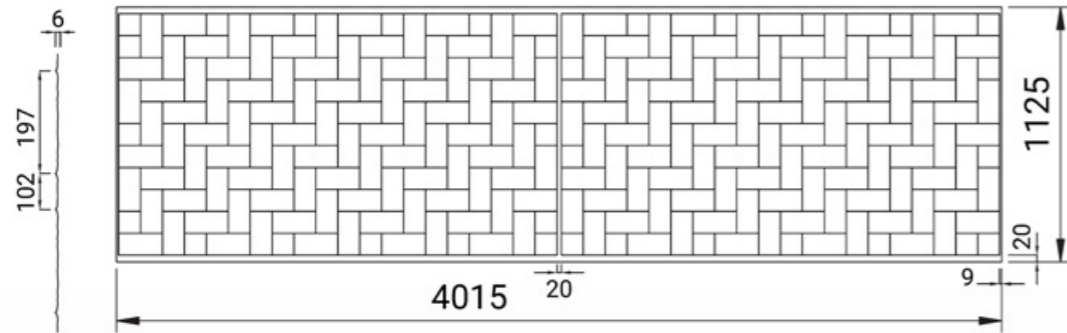

Dettaglio del getto

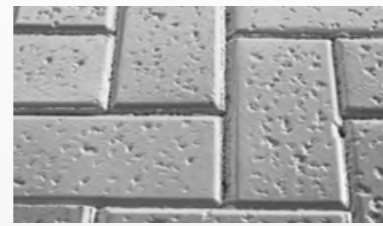

Dettaglio del getto

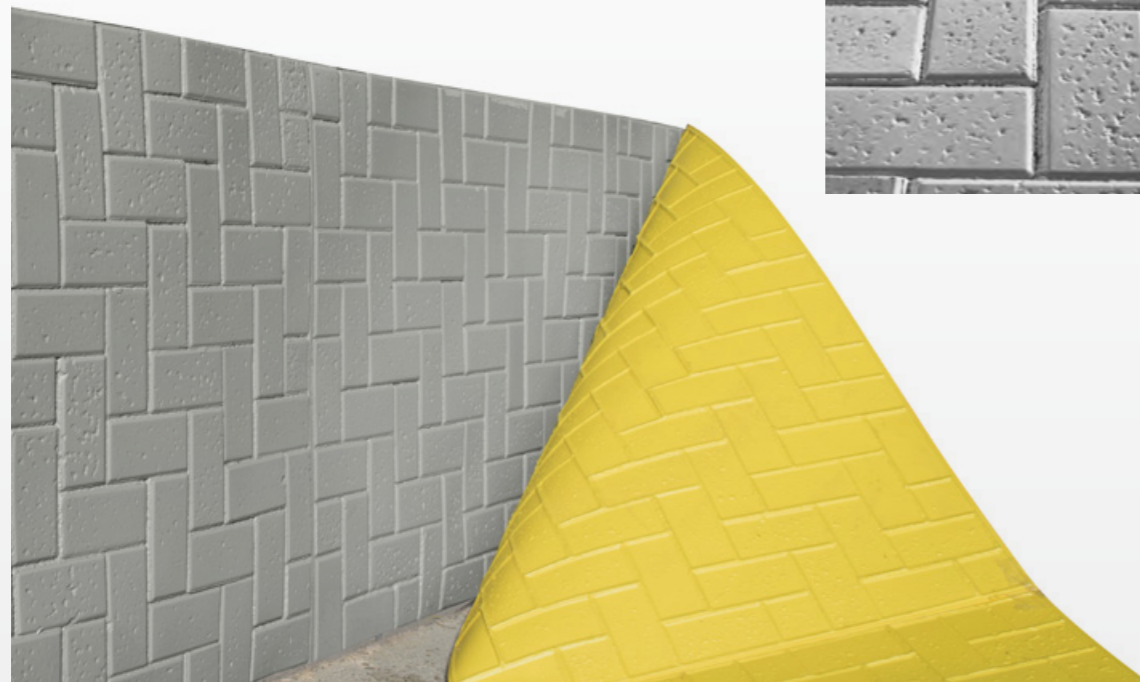

Stone collection

Stone collection

MOD. s81

MOD. s82

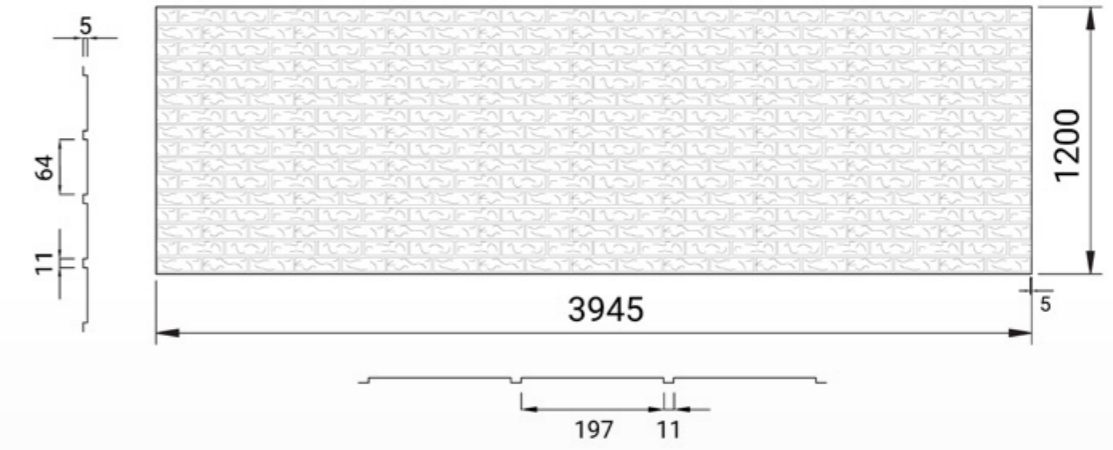
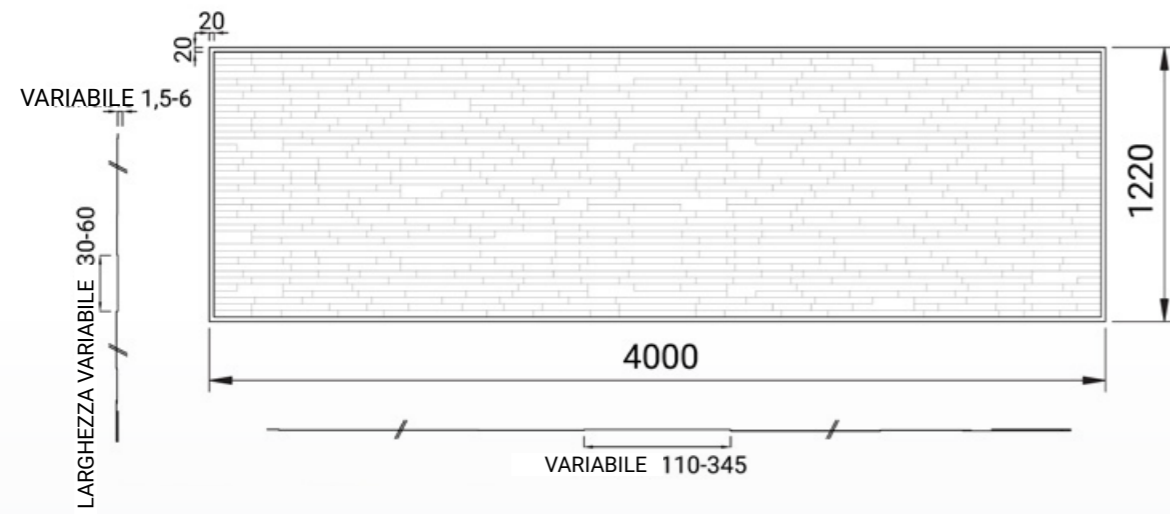

Dettaglio del getto

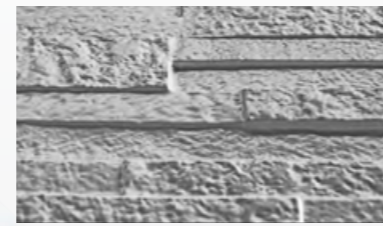

Dettaglio del getto

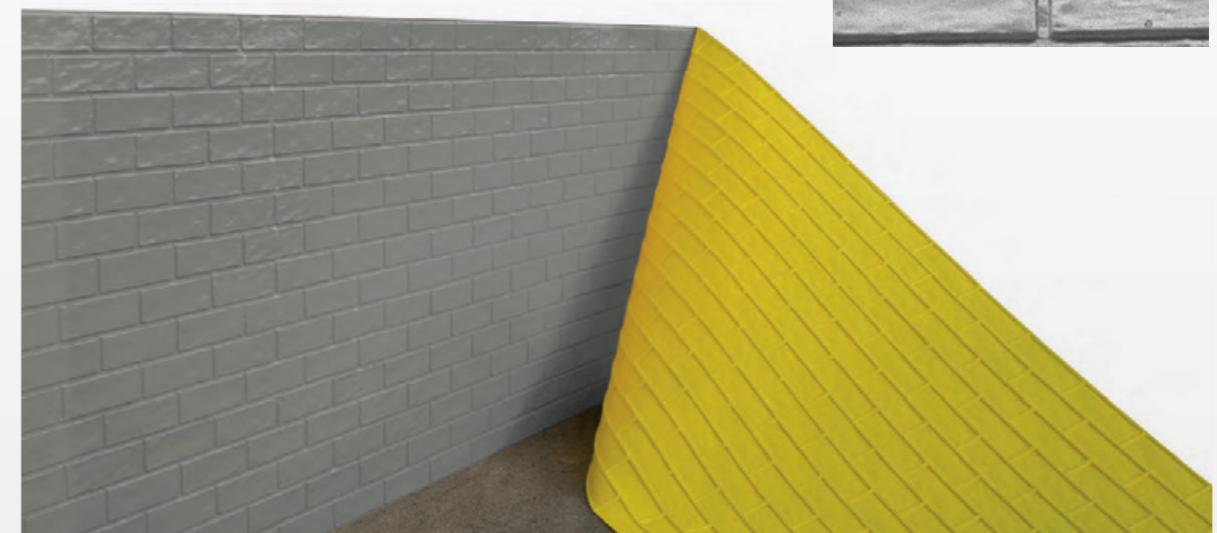
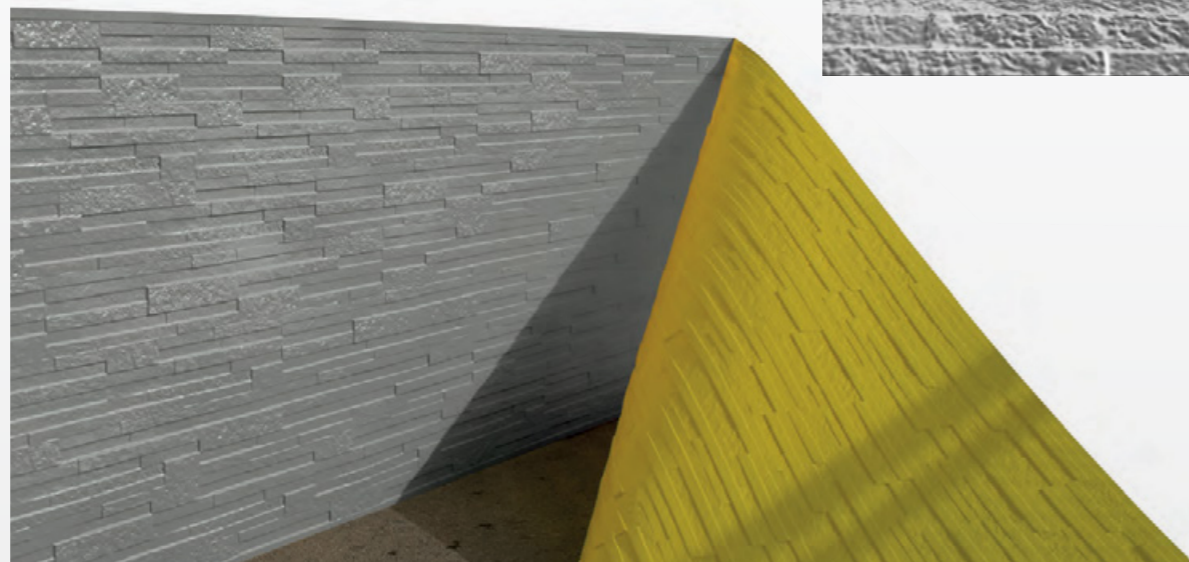
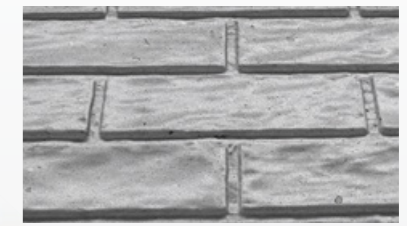

Stone collection

Stone collection



MOD. s83

MOD. s84

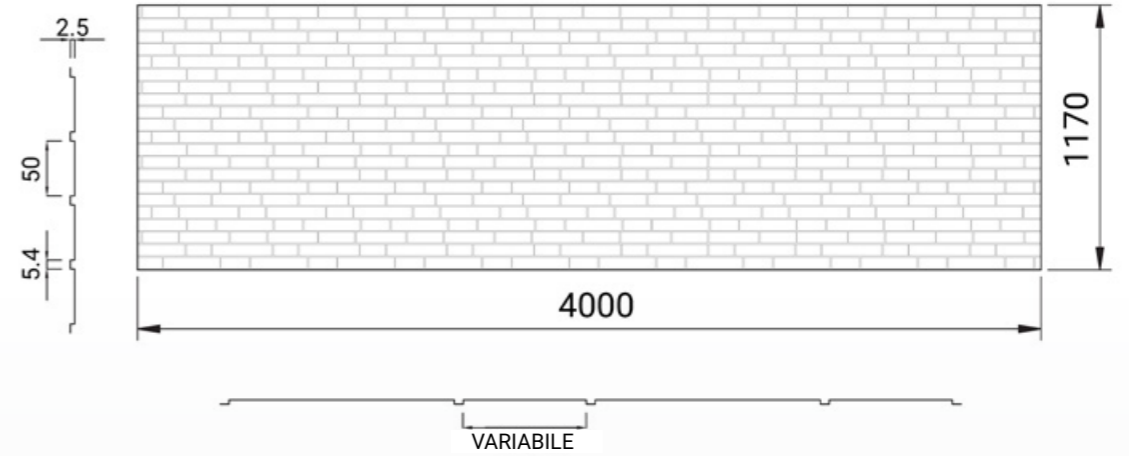
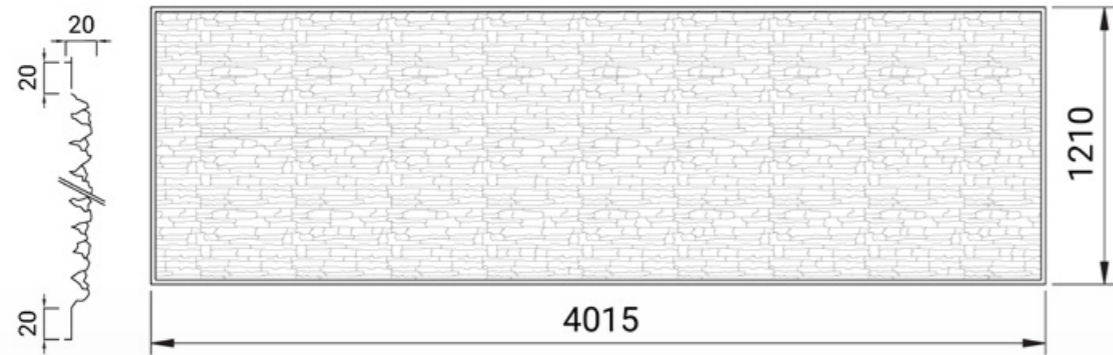

Dettaglio del getto

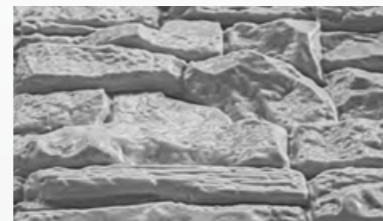

Dettaglio del getto

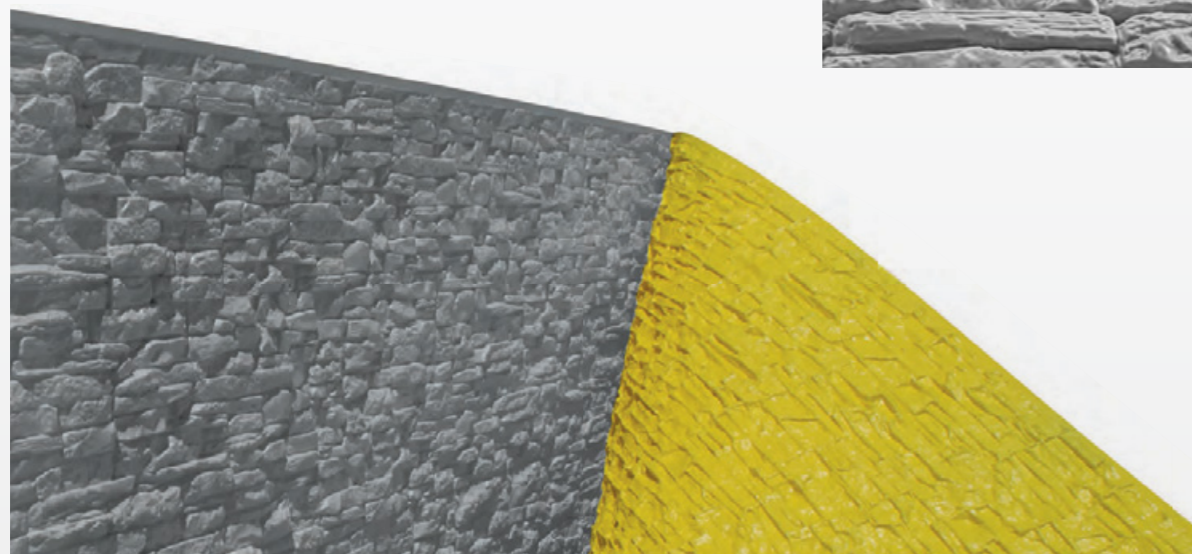

Stone collection

Stone collection

MOD. L00

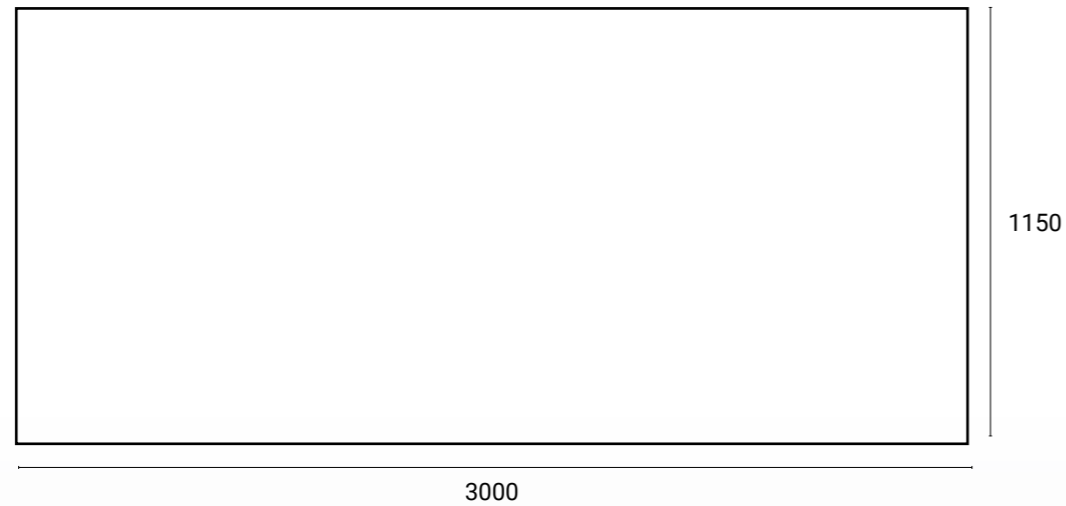

Pannello in MDF da 2,5 mm per getti in calcestruzzo liscio



# BETON<sup>TM</sup> ·UNO

## Linea matrici *ALTORILIEVO.*

Linea di matrici mono-getto dai rilievi molto accentuati, disponibili in 14 tipi di finiture, abbelliscono il calcestruzzo in modo semplice ed economico. Adatte per tutti i tipi di calcestruzzo, anche auto-compattanti, sono garantite per minimo un getto. Posa facile e veloce sui casseri tramite chiodi o con l'apposito adesivo, non necessitano disarmante e quindi i muri possono venire eventualmente tinteggiati immediatamente dopo il disarmo.

Le finiture della serie ALTORILIEVO conferiscono ad una costruzione un gradevole effetto. Possono essere posate all'interno delle casseforme in modo verticale, orizzontale o inclinate, per raggiungere il grado di personalizzazione desiderato. Ideali anche per la realizzazione di muri fonoassorbenti.

Le matrici ALTORILIEVO sono realizzate tramite accoppiatura di una lastra rigida in polistirene HIPS (lato getto) a un supporto in polistirolo ad alta densità.

Le sezioni indicate sono riferite alle matrici.



**MOD. 04E**

• 4000 x 1230 mm

**MOD. 06E**

• 4000 x 1230 mm

Dettaglio del getto

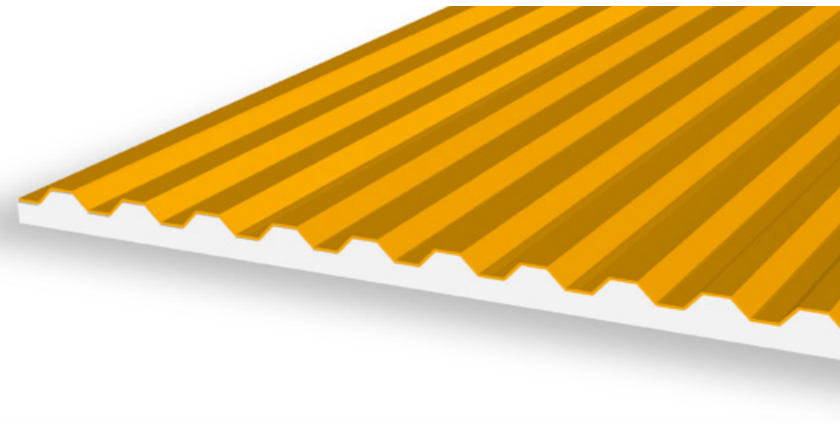
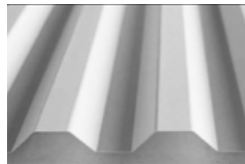

Dettaglio del getto

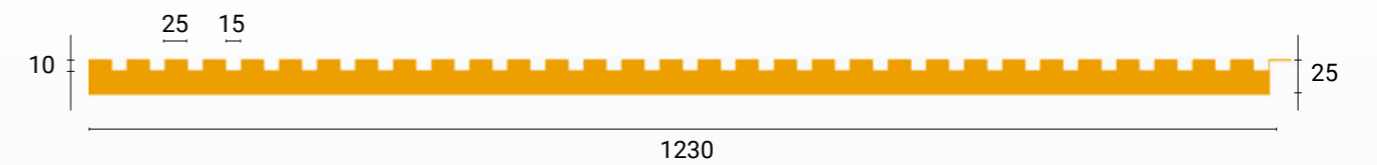
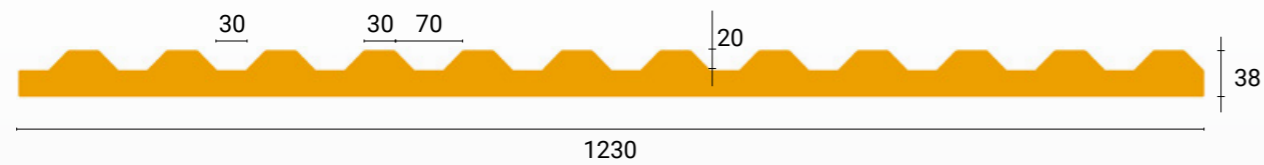
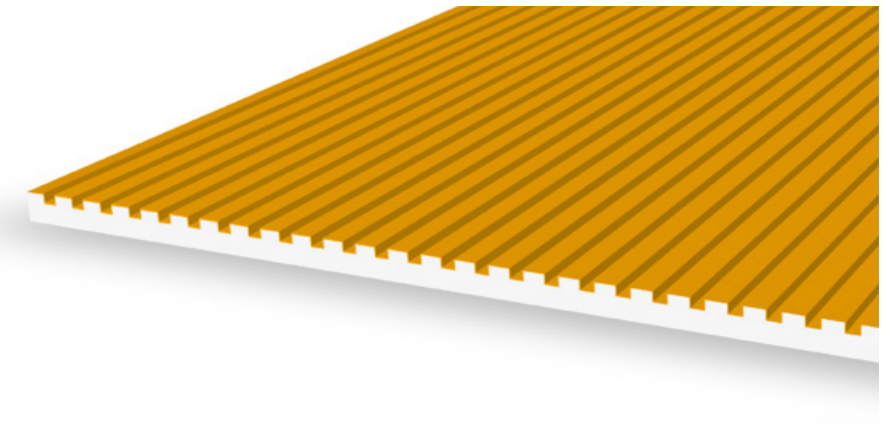
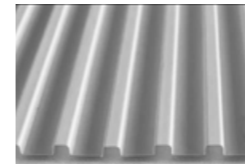

**MOD. 05E**

• 4000 x 1140 mm

**MOD. 08E**

• 4000 x 1200 mm

Dettaglio del getto

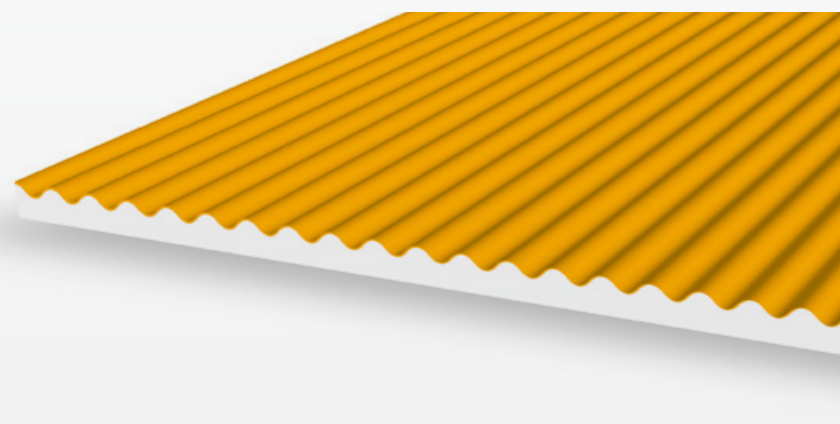
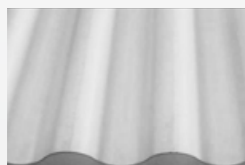

Dettaglio del getto

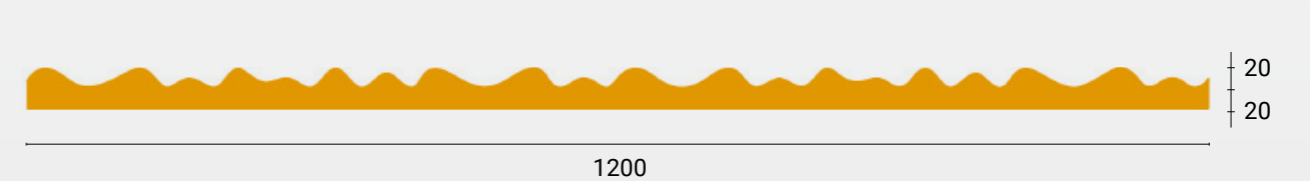
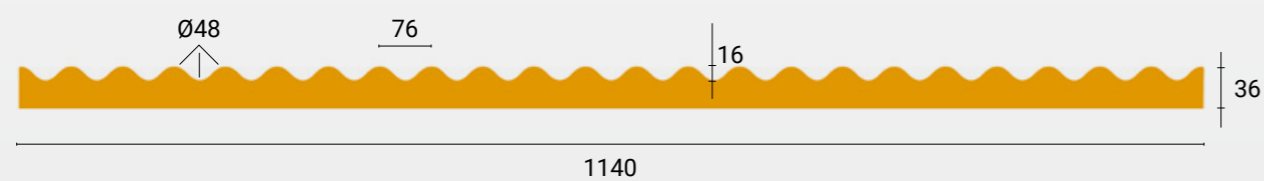
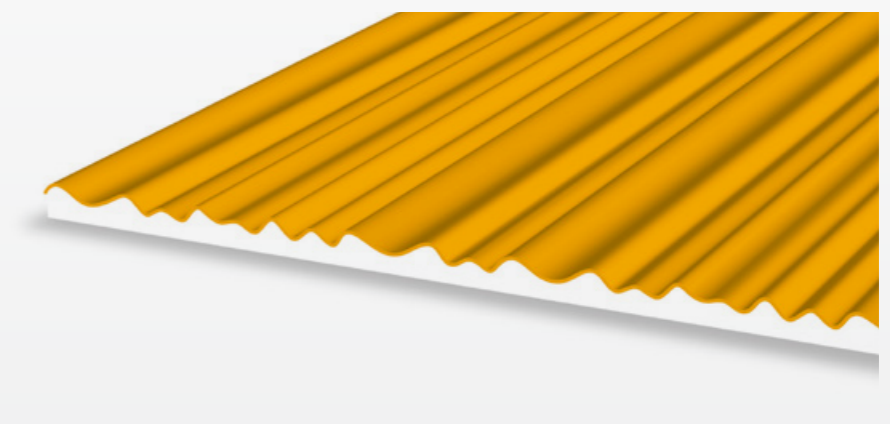

**MOD. 09E**

• 4000 x 1185 mm

Dettaglio del getto

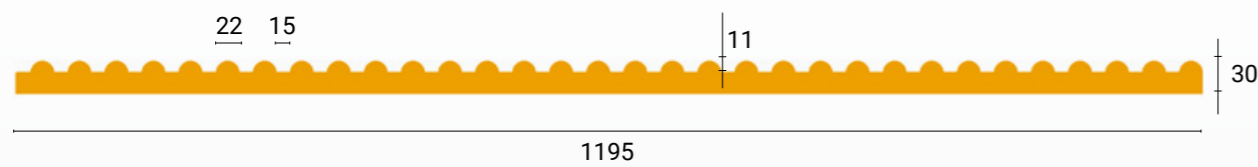
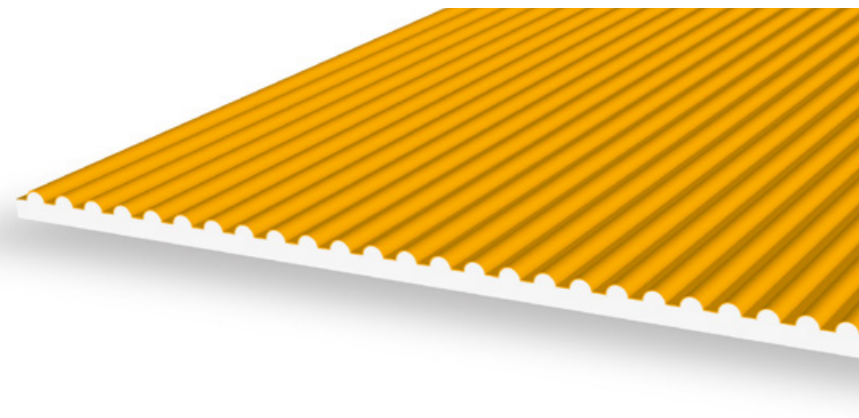
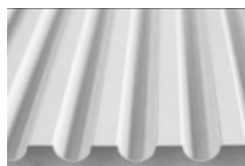

**MOD. 11E**

• 4000 x 1219 mm

Dettaglio del getto

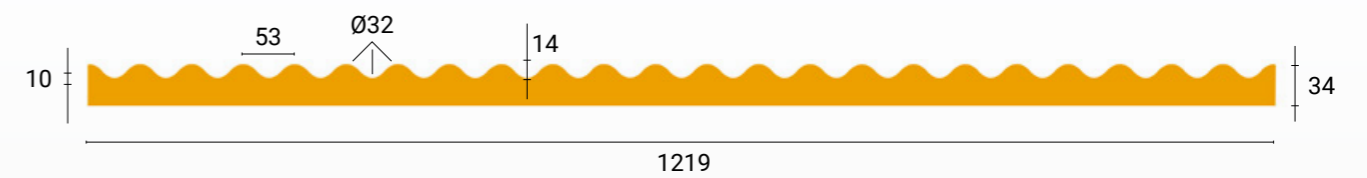
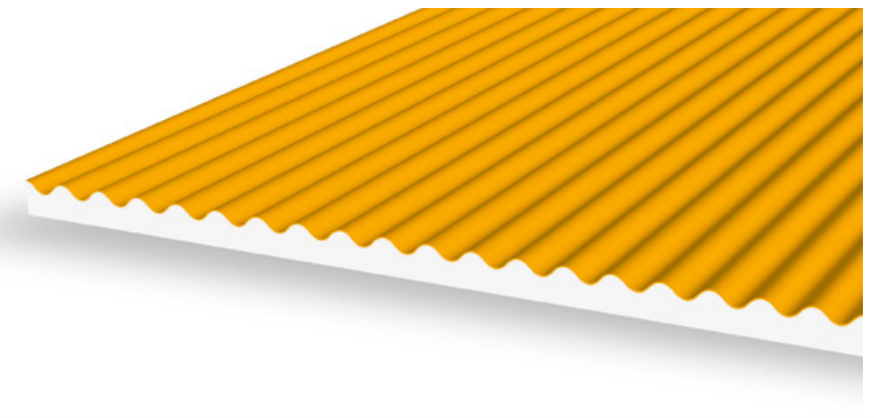
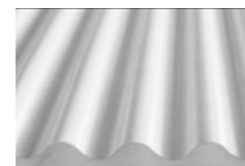

**MOD. 10E**

• 4000 x 1250 mm

Dettaglio del getto

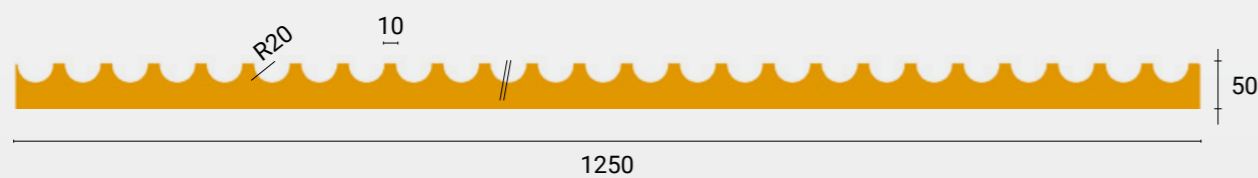
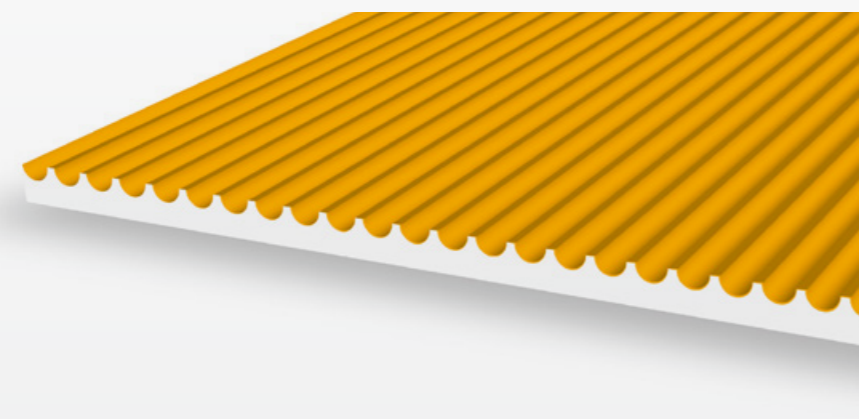
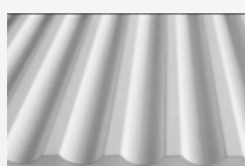

**MOD. 12E**

• 4000 x 1215 mm

Dettaglio del getto

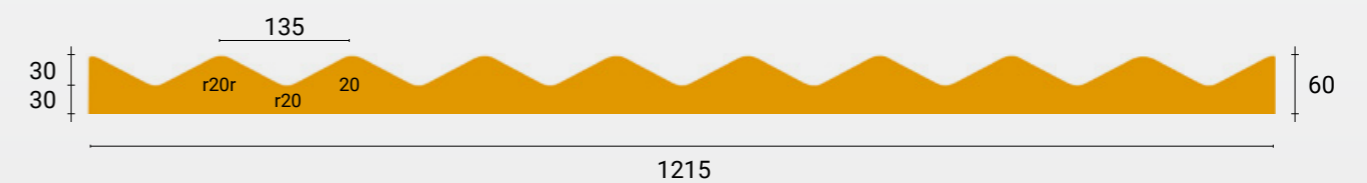
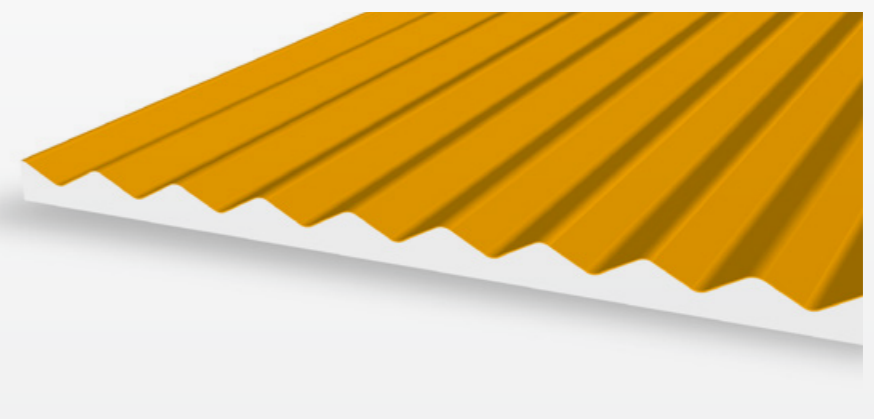



**MOD. 13E**

• 4000 x 1200 mm

Dettaglio del getto

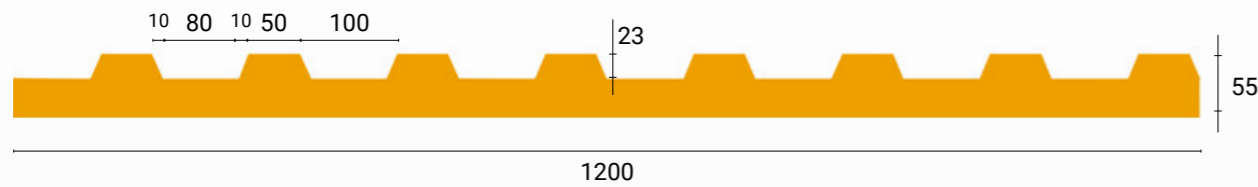
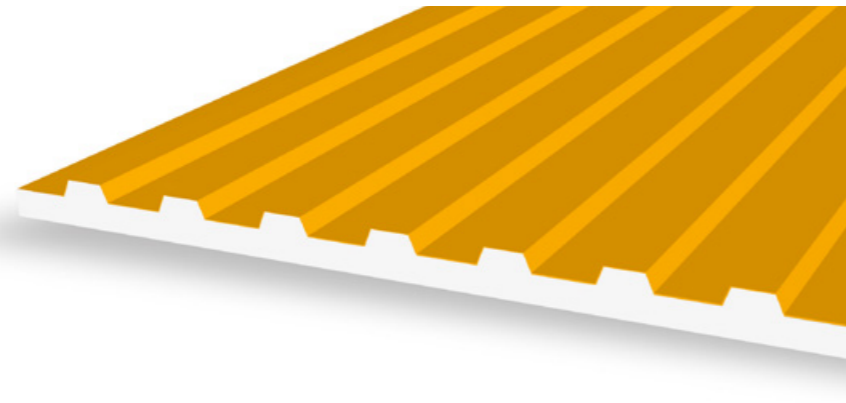
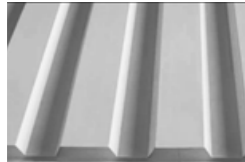

**MOD. 15E**

• 4000 x 1200 mm

Dettaglio del getto

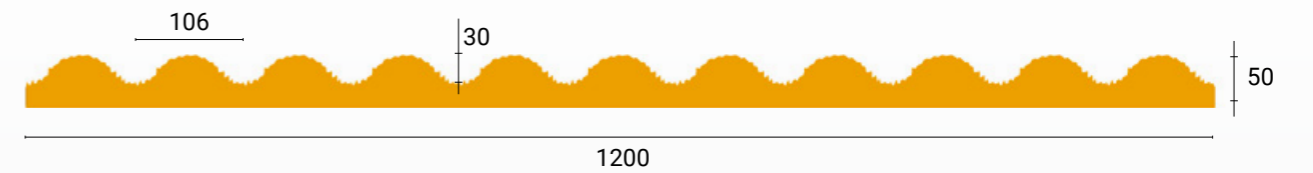
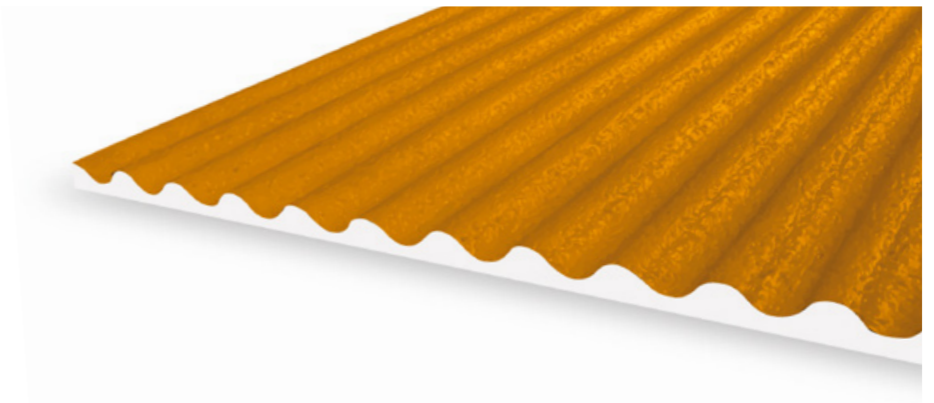
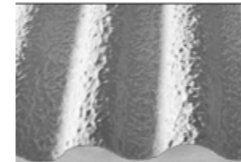

**MOD. 14E**

• 4000 x 1210 mm

Dettaglio del getto

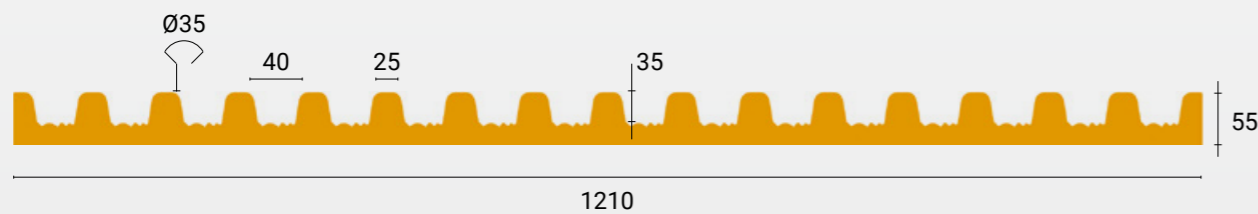
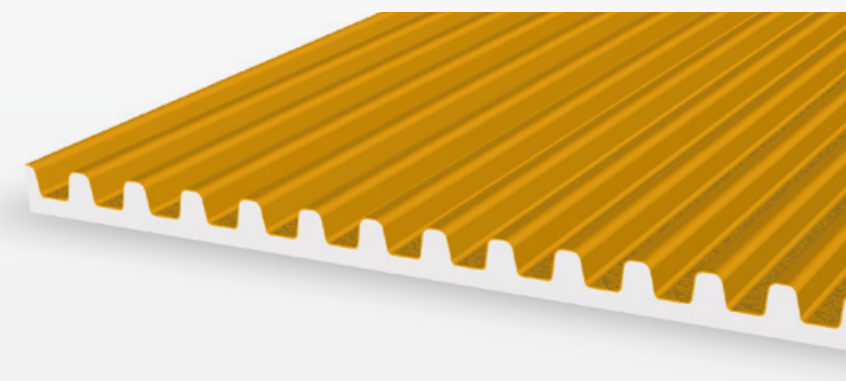
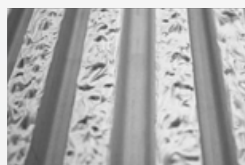

**MOD. 16E**

• 4000 x 1200 mm

Dettaglio del getto

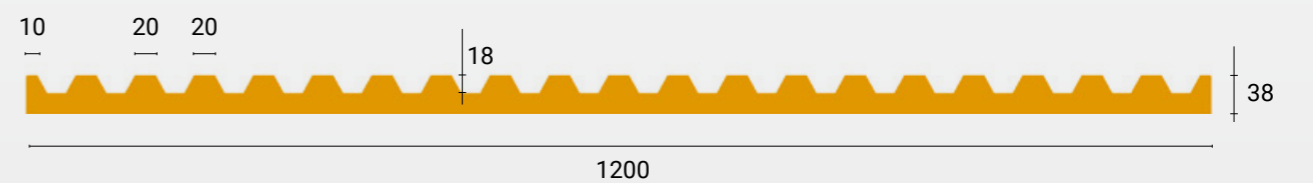
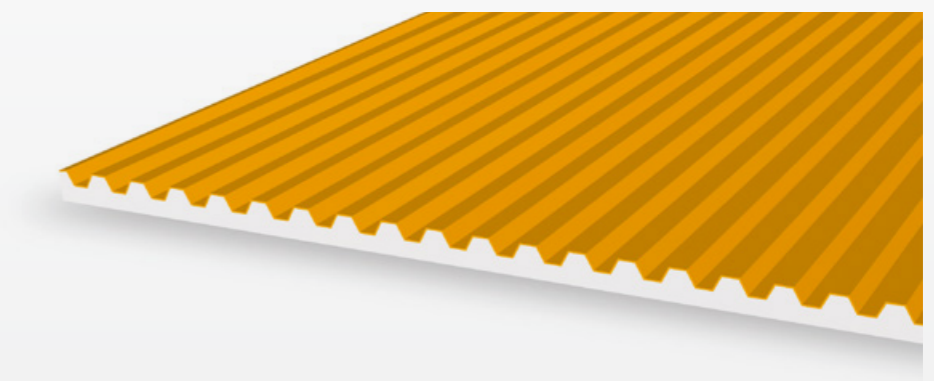
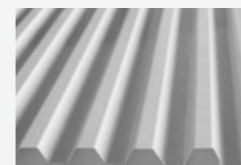

**MOD. 24E**

• 4000 x 1205 mm

Dettaglio del getto

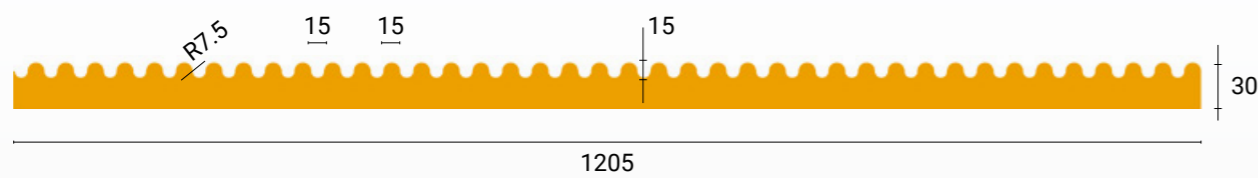
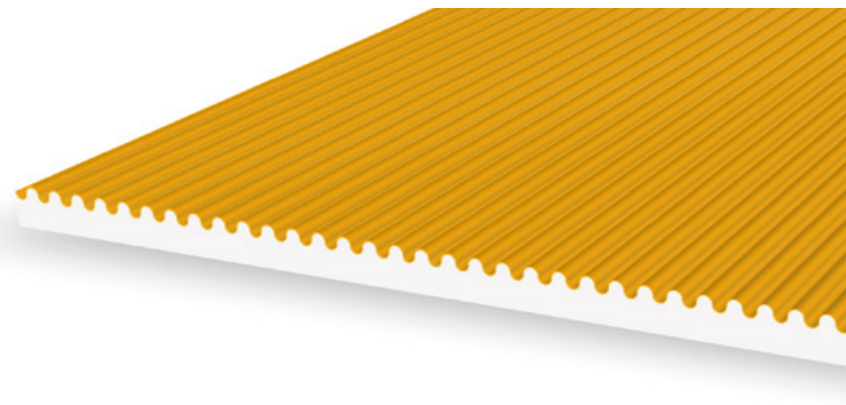
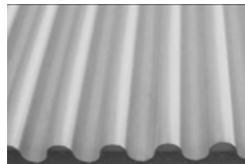

**MOD. 31E**

• 4000 x 1150 mm

Dettaglio del getto

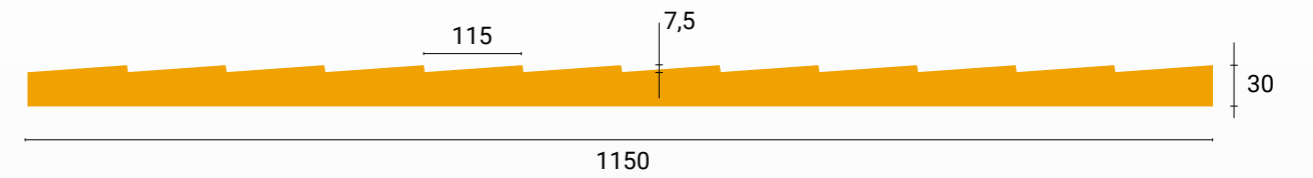
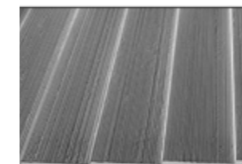

**MOD. 30E**

• 4000 x 1150 mm

Dettaglio del getto

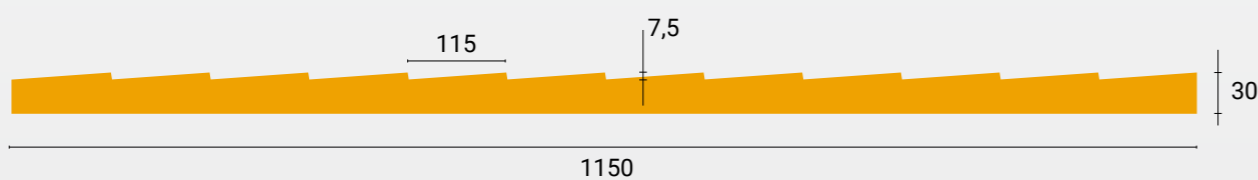
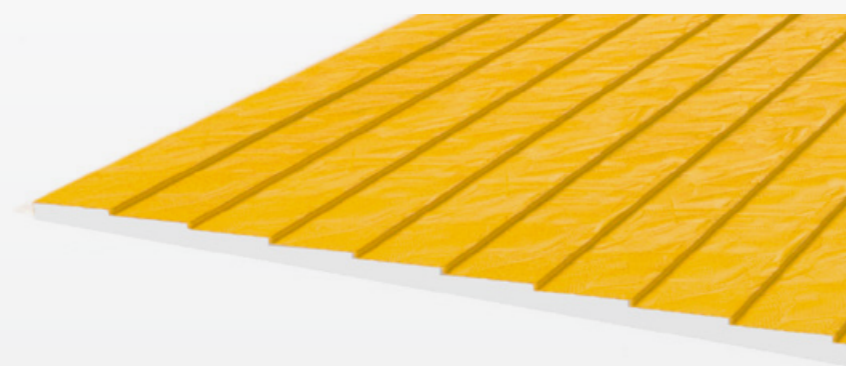
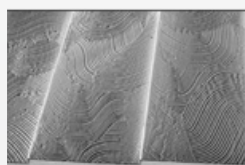

**MOD. 62E**

• 4000 x 1200 mm

Dettaglio del getto

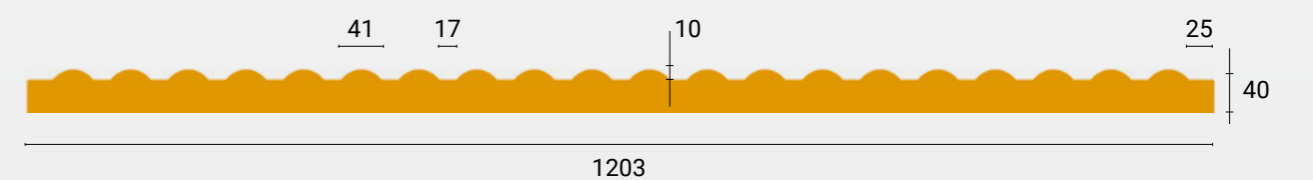
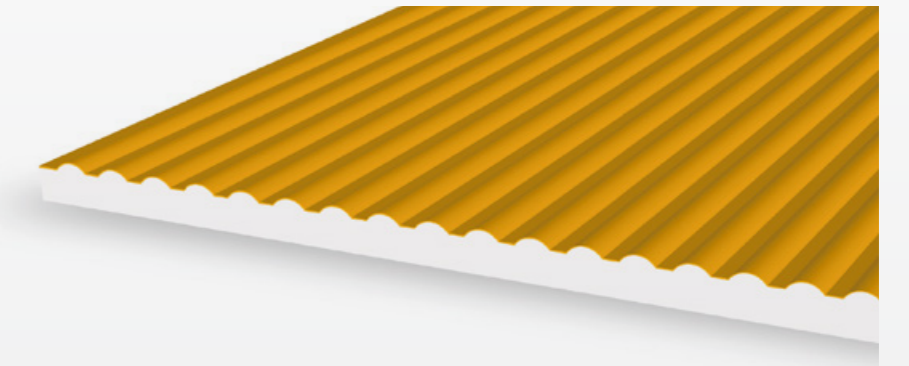
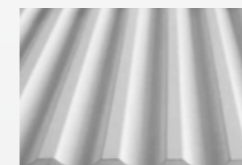



MOD. 67E

• 4000 x 1150 mm

Dettaglio del getto

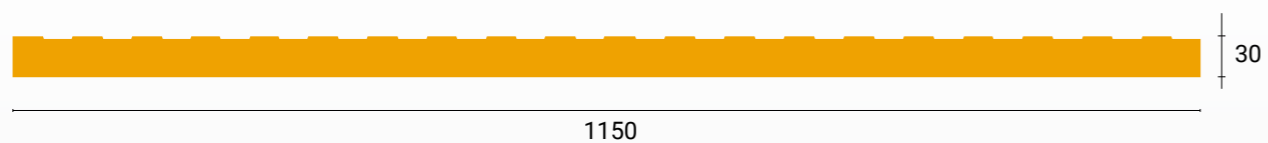
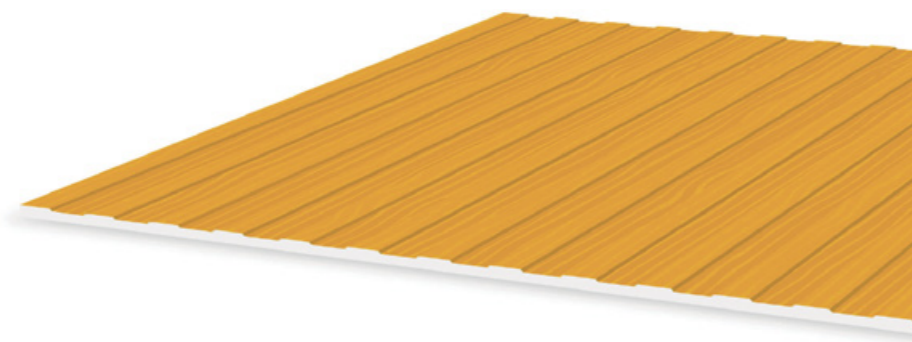
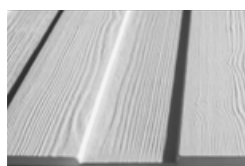



# BETON·UNO

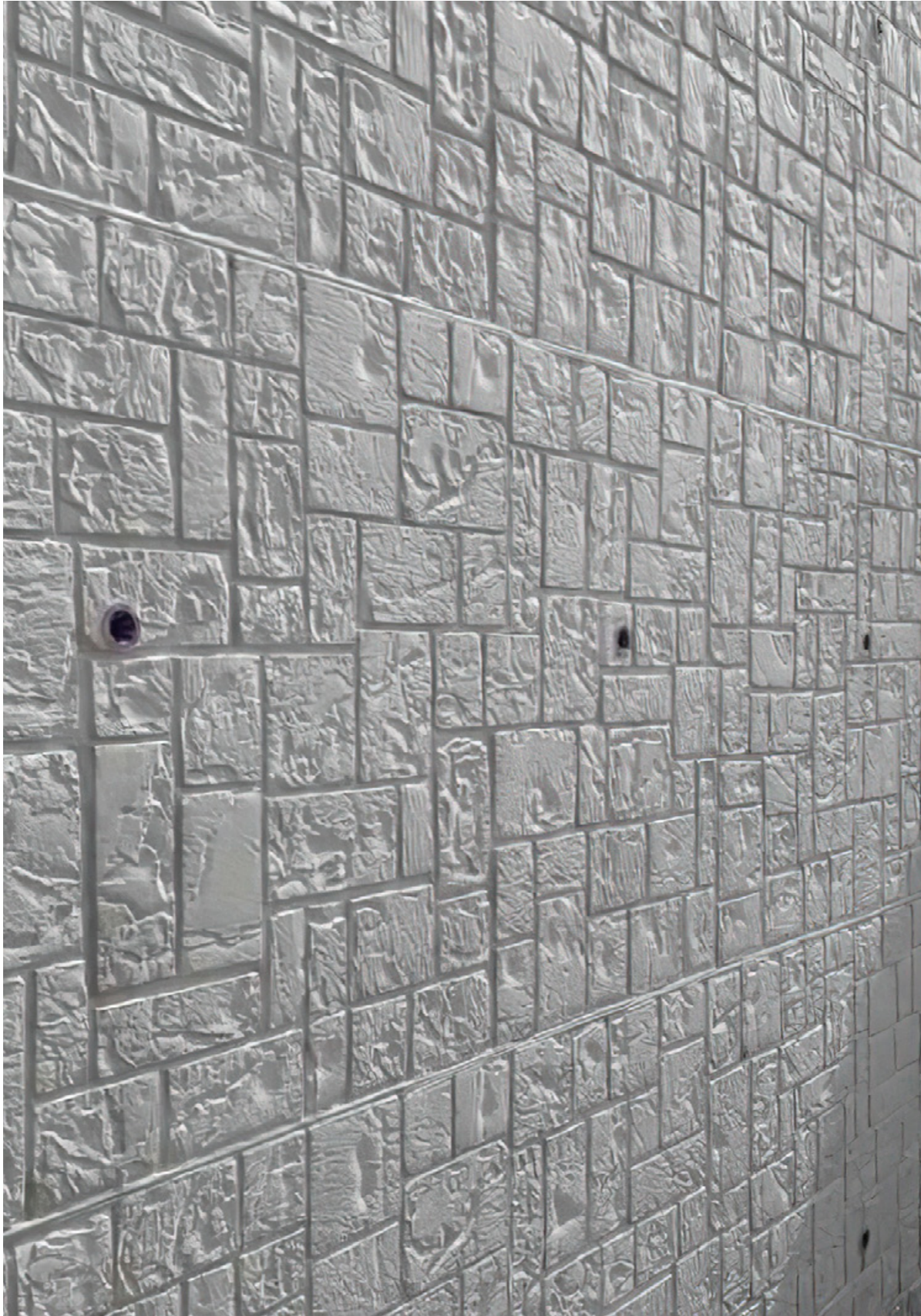

# BETON·UNO





**Beton Uno** div. Virage Srl

---

Via Treves 72 - 20090 Trezzano s/Naviglio (MI) / Tel. 02 4840 3101 / [info@beton-uno.it](mailto:info@beton-uno.it)  
P. Iva/Cod. Fisc./Reg. Impr. Mi IT13360840154 CCIAA Milano R.E.A. - n. 1644962 Cap. soc. Euro 10.000,00 i.v.